

**BRUKSANVISNING
INSTRUCTION MANUAL**

Namron Zigbee termostat for panelovn PRO

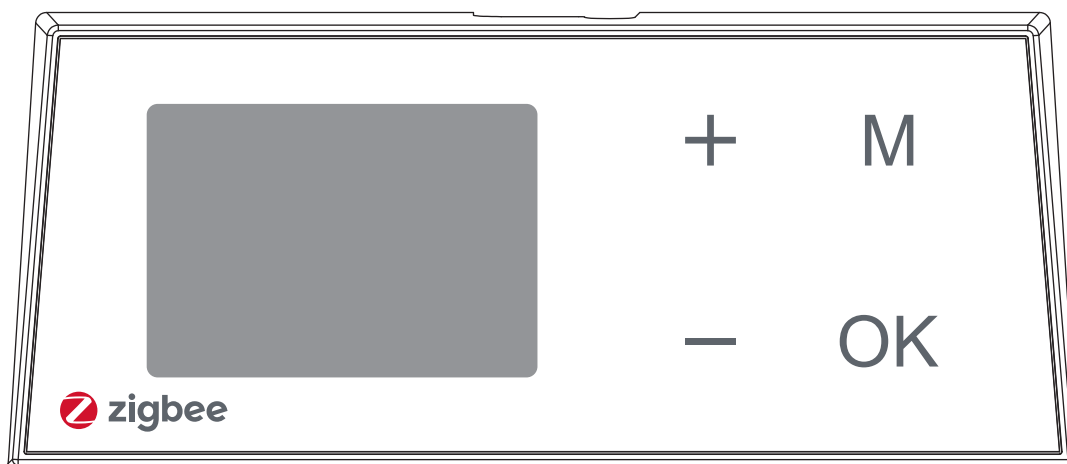



BRUK / USE

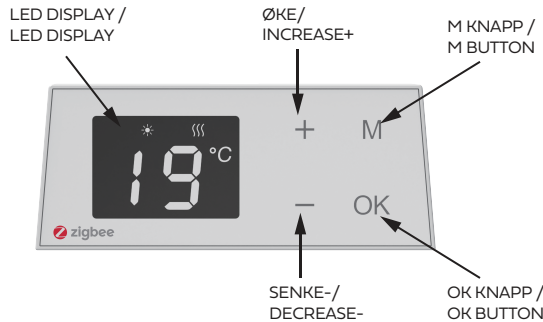

BRUK MED PROGRAM

1. Sett i kontakten og skru på strømbryteren. Displayet vil nå vise temperaturen.
2. Kort trykk på "M"-knappen og bruk + / - knappene for å navigere til menyvalget "AP". Trykk på "OK"-knappen for å gå inn. Trykk deretter på "+" / "-" for å bytte mellom Ad og rE i menyen. Velg Ad for å aktivere Zigbee-tilkoblingen, nettverksikon vil lyse kontinuerlig når tilkoblingen er vellykket. Velg rE for å slette den vellykkede tilkoblingen, og nettverksikon vil blinke.
3. Se QR-koden nedenfor for Zigbee IM til panelovnen for videre instruksjoner.



User manual

BRUK UTEN PROGRAM

1. Sett inn strømpluggen og slå på strømbryteren. Skjermen vil vise temperaturen.
2. Velg Komfort modus (viser "nR") eller ECO modus (viser "E C") ved å trykke på "OK"-knappen og holde knappen inne til "nR" eller "E C"-symbolet vises på skjermen.
3. Når omgivelsestemperaturen er lavere enn innstilt temperatur, vil varmeovnen starte oppvarming automatisk. Varmeikonet vil vises på skjermen.
4. Trykk på "+" eller "-" for å stille inn ønsket temperatur. Temperaturen kan justeres mellom 5-35°C. Trykk og hold inne "+" eller "-" for å justere temperaturen raskere. Fabrikkinnstillingen er KOMFORT = 21 °C, ECO = 17 °C.
5. Trykk "OK" for å velge "o F" for å sette apparatet i standby modus.
6. Trykk på "OK" og velg "F r" for å gå inn i Anti-frostmodus. Temperaturen er fast innstilt på 7 °C og kan ikke justeres.
7. Trykk på "OK" og velg "R U" for å gå inn i automatisk modus. Temperaturen for en tidsperiode kan bare stilles inn via APPEN når enheten er lagt til et Zigbee-nettverk.

1) TIDSINNSTILLING

1. Trykk på "M" knappen og benytt + / - knappene for å navigere deg frem til menyvalg "td". Trykk på "OK" knappen for å gå inn i programmet. Varmeovnen vil gå til menyen for tid.
2. Trykk på "+" / "-" for å stille inn ukedagen (velg fra d1 til d 7). Trykk "OK" for å lagre og gå til innstilling for time.
3. Trykk på "+" / "-" for å stille inn timen på dagen (velg fra 00 til 23). Trykk "OK" for å lagre og gå til innstilling for minutt.
4. Trykk på "+" / "-" for å stille inn minuttene (velg fra 00 til 59). Trykk "OK" for å lagre. Varmeovnen vil gå tilbake til arbeidsmodus og temperaturinnstillingen.

2) PROGRAMVALG

Trykk kort på OK for å velge P1, P2, P3 eller P4.

P1, P2, P3 forhåndsinnstilt programmodus

1. Trykk kort på OK for å velge P1, P2, P3 .
2. Etter å ha blinket i 5 sekunder, vil skjermen vise innstilt temperatur.

USE WITH PROGRAM

1. Insert the power plug and turn on the power switch. The display will show the temperature.
2. Short press "M" button and use + / - buttons to navigate to menu option "AP". Press "OK" button to enter. Then press "+" / "-" to switch between Ad and rE in the menu. Select "Ad" to enable the Zigbee connection, the network icon will stay lit once the connection is successful. Select "rE" can delete the successful connection, and the network icon will flash.
3. Refer to below QR code for Zigbee IM of the panel heater for further instructions.



User manual

USE WITHOUT PROGRAM

1. Insert the power plug and turn on the power switch. The display will show the temperature.
2. Choose Comfort mode (display "nR") or ECO mode (display "E C") by pushing the "OK" button, hold the button until "nR" or "E C" symbol on the display.
3. When the environment temperature is below set temperature, the heater will start heating automatically. The heating icon will be shown in the display.
4. Press "+" or "-" to set the desired temperature. The temperature can be adjusted between 5-35°C. Press and hold "+" or "-" to adjust the temperature in a faster speed. Factory default setting is COMFORT = 21°C; ECO = 17°C.
5. Press "OK" to select "o F" to turn the appliance into standby.
6. Press "OK" and select "F r" to enter anti-freeze mode. The temperature is fixed at 7°C and cannot be adjusted.
7. Press "OK" and select "R U" to enter Auto mode. Only when the device is added to a Zigbee network, the temperature of a time period can be set through APP.

1) TIME SETTING

1. Short press the M button and use + / - buttons to navigate to menu option "td". Short press "OK" button to enter setting. The heater will enter Time setting interface.
2. Press "+" / "-" to set the day of the week (choose from d1 to d7). Press "OK" to save and enter hour setting.
3. Press "+" / "-" to set the hour of the day (choose from 00 to 23). Press "OK" to save and enter minute setting.
4. Press "+" / "-" to set the minute (choose from 00 to 59). Press "OK" to save. The heater will go back to the working mode and temperature.

2) PROGRAM SELECTION

Short press OK to choose P1 or P2 or P3 or P4.

P1 or P2 or P3 pre-set program mode

1. Short press OK to select P1 or P2 or P3 .
2. After flashing 5 seconds, the display will show set temperature.

P1, P2 og P3 er forhåndsinnstilte programmer med følgende forhåndsinnstilte programmer:

P1,P2,P3 are default program with pre-set program as below:

| | | | | | | | |
|--|--|--|------------|-----------------|------------|--|------------|
| Ukentlige moduser/ Weekly modes | P1 (5-2) | Mandag-Fredag/Monday-Friday | | | | Lørdag-Søndag/Saturday-Sunday | |
| | P2 (6-1) | Mandag-Lørdag/Monday-Saturday | | | | Søndag/Sunday | |
| | P3 (7-0) | Mandag-Søndag/Monday-Sunday | | | | | |
| | P4 (0-7) | | | | | Mandag-Søndag/Monday-Sunday | |
| Innstilling av tid og program/ Time and program setting | Begivenhet/Event | 4 oppvarmingssykluser/4 heating cycles | | | | 2 oppvarmingssykluser/2 heating cycles | |
| | Tidsperiode/ Time period | Komfort/Comfort | Eco | Komfort/Comfort | Eco | Komfort/Comfort | Eco |
| | Tid / Time | 6:00-9:00 | 9:00-16:00 | 16:00-23:00 | 23:00-6:00 | 7:00-23:00 | 23:00-7:00 |
| | Fabrikkinnstilling/ Factory setting | 21°C | 17°C | 21°C | 17°C | 21°C | 17°C |

P4 er et programmerbart ukesprogram

Hvis du ønsker å endre P4-programmet, følger du trinnene nedenfor:

1. Trykk på "M" knappen og benytt + / - knappene for å navigere deg frem til menyvalg Pr.
2. Trykk OK-knappen for å gå inn i P4-programmet.
3. Etter å ha kommet inn i P4-programmet:

Trinn 1, sett ukedagen, skjermen viser d1, trykk + eller - for å velge d1/d2/d3/d4/d5/d6/d7. Trykk OK-knappen for å bekrefte.

Trinn 2, sett timen på dagen, skjermen viser 00H, trykk + eller - for å velge KOMFORT eller ECO. Trykk OK-knappen for å bekrefte.

KOMFORT modusen fungerer ved KOMFORT modusens temperatur.

ECO modusen fungerer ved ECO modusens temperatur.

Du kan endre temperaturen for KOMFORT og ECO ved å følge trinnene i BRUK UTEN PROGRAM" Nr. 4.

4. Gjenta de ovennevnte trinnene for å stille inn de gjenværende dagene og timene i uken. Trykk OK for å bekrefte. Skjermen vil blinke i 30 sekunder, og deretter gå tilbake til Pr-programmet. Pr-programmet vil blinke i 10 sekunder. Dette betyr at innstillingen er fullført. Varmeovnen vil følge programmet du har satt.

*Kontroll av hele programmet du har satt

Trykk på "M" knappen og benytt + / - knappene for å navigere deg frem til menyvalg Pr. Trykk og hold inne + og - knappen samtidig i 5 sekunder, skjermen vil rulle ut hele ukens program du har satt. Etter det vil den returnere til pr-grensesnittet og blinke i 10 sekunder. Deretter vil varmeovnen gå tilbake til arbeidsmodus.

P4 is a Customized weekly program

If you want to revise the P4 program, follow below steps:

1. Short press the M button and use + / - buttons to navigate to menu option "Pr".
2. Press OK button enter P4 interface.
3. After entering P4 interface:

Step 1, set day of the week, display show d1, press + or – choose d1/d2/d3/d4/d5/d6/d7. Press OK button to confirm.

Step 2, set the hour of the day, display show 00H, press + or – choose COMFORT mode or ECO mode. Press OK button to confirm.

The Comfort mode works at the temperature of Comfort mode.



The ECO mode works at the temperature of ECO mode.













You can change the temperature of Comfort mode and ECO mode following steps in use without program" No.4.

4. Repeat above steps to set the rest day and hours of the week. Press OK to confirm. Display will flash 30s and then back to the interface of Pr. Pr interface will flash 10s. It means the setting is complete. The heater will work the program you have set.

*Checking of the whole program that you have set

Short press the M button and use + / - buttons to navigate to menu option "Pr". Press and hold + and – button at the same time for 5s, the display will roll out with the whole week program you have set. After that, it will return to pr interface and flash 10s. Then heater will be back to working mode.

| | |
|---|--|
|  <p>Kalibrere temperaturføler / Temperature calibration</p> | <p>Trykk på "M" knappen og benytt + / - for å navigere deg frem til menyvalg "C". Trykk kort på "OK" for å gå inn i C - menyen for kalibrering av temperaturføler. "0" vil vises som standard på skjermen. Trykk på "+" / "-" for å stille inn kompensasjonstemperaturen innenfor ±5°C.</p> <p>Short press the "M" button and use + / - to navigate to menu option "C". Short press "OK" to enter C — temperature calibration setting interface. "0" will show on the display as default. Press "+" / "-" to set the compensation temperature within ±5°C.</p> |
|  <p>Adaptiv start/ Adaptive start</p> | <p>Trykk på "M" knappen og benytt + / - for å navigere deg frem til menyvalg "AS". Trykk "OK" for å gå inn i menyen for adaptive start. Skjermen vil vise "on" eller "oF". Trykk på "+" eller "-" for å endre valget, og trykk på "OK" igjen for å bekrefte. Når "on" er valgt, er Adaptiv start aktivert. Når "oF" er valgt, er funksjonen deaktivert. Standardinnstillingen er "oF".</p> <p>Denne funksjonen beregner hvor lang tid det tar å oppnå ønsket temperatur og aktiverer varmeovnen i god tid for å sikre at "komfort"-temperaturen nås til oppgitt tidspunkt.</p> <p>Funksjonen kan slå på apparatet for oppvarming maksimalt 2 timer på forhånd.</p> <p>Merk: Denne funksjonen gjelder bare for P1, P2, P3-programmet.</p> <p>Short press the "M" button and use + / - to navigate to menu option "AS". Press "OK" to enter Adaptive Start setting interface. The screen will show "on" or "oF". Press "+" or "-" to change the selection and press "OK" again to confirm. When "on" is selected, the Adaptive Start function is activated. When "oF" is selected, the function is deactivated. Default setting is "oF".</p> <p>This feature measures the thermal inertia of the room and turns on the heaters in advance to ensure "comfort" temperature is reached at the set time. This function can turn on the appliance for heating maximum 2 hours in advance.</p> <p>Remarks: This function applies for P1, P2, P3 program only.</p> |
|  <p>Hysteres-/ Hysteresis</p> | <p>Trykk på "M" knappen og bruk + / - for å navigere deg frem til menyvalg "Hy". Trykk deretter på "OK" for å gå inn i innstillingen. Trykk kort på "+" eller "-" for å stille inn hystereseverdi mellom 0,5 °C og 5 °C. Trykk deretter på "OK" for å lagre ønsket verdi. Standardinnstillingen er 0,5 °C.</p> <p>Short press the "M" button and use + / - to navigate to menu option "Hy". Then press "OK" to enter the setting. Short press "+" or "-" to set the hysteresis value between 0.5 °C and 5 °C. Then press "OK" to save the wanted value. The default setting is 0.5 °C.</p> |

| | |
|--|--|
| <p>Minnefunksjon/ Memory function</p> | <p>Etter strømavbrudd kan varmeovnen huske den innstilte temperaturen før strømbruddet og fortsette å fungere. Ved et strømbrudd vil varmeovnen opprettholde den interne klokken i 24 timer. Hvis strømmen er brutt i mer enn 24 timer, vil varmeovnen, når strømmen slås på igjen, gå tilbake til den sist brukte temperaturen, den interne klokken vil tilbakestilles til standardtid, og varmeovnen vil starte på nytt. Strømbrudd vil bli indikert av at skjermen blinker. Blinkingen vil fortsette til hvilken som helst av knappene trykkes på for å stoppe den.</p> <p>After the power is turned off, the heater can memorize the working set temperature before the power failure and continue to work. In the event of a power disconnection, the heater will keep the internal clock running for 24 hours. If the power is disconnected for more than 24 hours, when the power is turned on again, the heater will return to the last used temperature, the internal clock will return to the default time and start running again. The screen will flash, indicating that there is a power outage. The blinking state will continue until any button is pressed to cancel the blinking.</p> |
| <p> Justering av skjermens lysstyrke/ Adjustment of display brightness</p> | <p>Trykk på "M" knappen og benytt + / - for å navigere deg frem til menyvalg "dL". Trykk "OK" for å gå inn i dL - innstillingsgrensenettet for skjermlysstyrke. Du kan justere lysstyrken på skjermen. Standardinnstillingen er 3. Trykk på "+" / "-" for å velge mellom nivå 1 til 5. Nivå 1 er den mørkeste, mens 5 er den lyseste.</p> <p>Short press the "M" button and use + / - to navigate to menu option "dL". Press "OK" to enter dL—screen brightness setting interface. You can adjust the brightness of the screen. The default setting value is 3. Press "+" / "-" to choose from grade 1 to 5. Grade 1 is the darkest while 5 is the brightest.</p> |
| <p> Åpent-vindu-funksjon / Open window detection</p> | <p>Trykk på "M" knappen og benytt + / - for å navigere deg frem til menyvalg "Ud". Trykk "OK" for å gå inn i "Ud" – åpent vindusdeteksjonsinnstilling. Åpent-vindu-ikonet  vil da blinke. Trykk deretter på "+" / "-" for å velge «Av» eller «På». Trykk "OK" eller vent i femsekunder uten å trykke på noen knapper for å bekrefte innstillingen. Standardinnstillingen for denne funksjonen er Av. Når funksjonen er aktivert vil Åpent-vindu-ikonet  vises i displayet. Detekterer ovnen et temperaturfall, vil den automatisk gå over i antifrost-modus og operere på 7°C mens Åpent-vindu-ikonet  blinker. Om temperaturen stiger vil ovnen gå tilbake til forrige modus med Åpent-vindu-funksjonen på. Du kan også gå tilbake til forrige modus ved å trykke på en vilkårlig knapp. Velg «Av» for å deaktivere Åpent-vindu-funksjonen.</p> <p>Short press the "M" button and use + / - to navigate to menu option "Ud". Press "OK" to enter "Ud"—open window detection setting. The open window icon  will be flashing. Then press "+" / "-" to choose «on» or «oF». Press "OK" or after five seconds without operating the display, and the setting will be saved. The default factory setting for this function is oF.</p> <p>If «on» is selected, the window detection function is activated and the open window icon  will be visible in the display. When temperature drop is detected, the appliance will automatically enter anti-freeze mode (heater works at 7°C, with open window icon  flashing).</p> <p>If temperature rises, the appliance will go back to previous working mode. You can also press any button to go back to previous mode. Choose «oF» to deactivate the detection function.</p> |
| <p> Barnesikring / Child Lock</p> | <p>Trykk på "M" knappen og benytt + / - for å navigere deg frem til menyvalg "CL". Trykk "OK" for å gå inn i "CL"—barnesikringsinnstilling. Trykk deretter "+" / "-" for å velge «on» eller «oF». Du kan velge «on» og trykke kort på «OK» for å aktivere barnesikringen, og CL vil blinke tre ganger sakte. Velg «oF» og trykk kort på "OK" for å deaktivere barnesikringen, CL vil blinke tre ganger og deretter gå tilbake til hovedgrensenettet. Barnesikring kan også aktiveres/deaktiveres ved å holde inne "+" og "-" i 5 sekunder.</p> <p>Short press the "M" button and use + / - to navigate to menu option "CL". Press "OK" to enter "CL"—child lock setting. Then press "+" / "-" to choose «on» or «oF». You can choose «on» and short press "OK" to activate the child lock, and CL will flash three times slowly. Choose «oF» and short press "OK" to deactivate the child lock, CL will flash three times and then return to the main interface. Child lock can also be activated / deactivated by holding "+" and "-" for 5 seconds.</p> |
| <p> Tilbakestill til standardinnstilling / Reset the thermostat to default</p> | <p>Trykk på "M" knappen og benytt + / - for å navigere deg frem til menyvalg "rE". Etter å ha trykket "OK" for å bekrefte, viser displayet "rE". Fortsett å holde "OK" i 3 sekunder for å bekrefte tilbakestillingen, panelovnen vil bli satt tilbake til fabrikkinnstillingen. Eller trykk kort på "M" for å gå tilbake til hovedmenyen og avbryte tilbakestillingen.</p> <p>Short press the "M" button and use + / - to navigate to menu option "rE". After pressing "OK" to confirm, the display shows "rE". Keep holding "OK" for 3 seconds to confirm the reset, heater will be set back to the factory default setting. Or short press "M" to return to the main menu and cancel the reset.</p> |
| <p> Skrü Av/På lyset i displayet / Light on /off the display</p> | <p>Trykk på "M" knappen og benytt + / - for å navigere deg frem til menyvalg "dA". Trykk deretter "OK" for å gå inn i innstillingen. Trykk kort på "+" / "-" for å velge «on» eller «oF», og trykk "OK" igjen for å bekrefte. Hvis «on» er valgt, aktiveres den automatiske skjermav-funksjonen, displaylyset vil slå seg av etter 30 sekunder uten å bli betjent. Trykk på en hvilken som helst tast for å tenne den igjen.</p> <p>Short press the "M" button and use + / - to navigate to menu option "dA". Then Press "OK" to enter the setting. Short press "+" / "-" to choose «on» or «oF», and press "OK" again to confirm. If «on» is selected, the automatic screen-off function is activated, the display light will turn off after 30 seconds without being operated. Press any key to light it again.</p> |
| <p> OTA-oppgradering/ OTA Upgrade</p> | <p>Trykk på "M" knappen og benytt + / - for å navigere deg frem til menyvalg "ot". Trykk deretter "OK" for å gå inn i innstillingen. Trykk kort på "OK" for å aktivere BLE OTA, eller trykk på "M" for å avbryte og gå tilbake til hovedmenyen. Bekreft at aktiveringsdisplayet viser «UP» – aktiver BLE for å koble til BLE OTA-oppgraderingsapplikasjonen.</p> <p>Short press the "M" button and use + / - to navigate to menu option "ot". Then press "OK" to enter the setting. Short press "OK" to activate BLE OTA or press "M" to cancel and return to the main menu. Confirm that the activation display shows "UP" - activate BLE to connect to the BLE OTA upgrade application.</p> |



Skjule eller vies et program i programmenyen /Hide or show a program in the program selector

Trykk på "M" knappen og benytt + / - for å navigere deg frem til menyvalg "PS". Trykk "OK" knappen for å gå inn i innstillingen.

Benytt + / - knappene for å navigere deg frem til programmet du ønsker å vise eller skjule, trykk deretter på OK knappen. Benytt + / - knappen for å skifte mellom valget "on" og "oF". Bekreft valget med å trykke på OK knappen.

"on" - Programmet vises i programmenyen
"oF" - Programmet skjules i programmenyen

Eksempel:

I PS menyen, benytt + / - knappene for å navigere deg frem til programmet EC, trykk deretter på OK knappen. Benytt + / - knappen for å skifte mellom valget "on" og "oF". Bekreft valget med å trykke på OK knappen. Programvalget vil nå vises eller skjules i programmenyen avhengig av valg.

Short press the "M" button and use + / - to navigate to menu option "PS". Press "OK" button to enter the setting.

Use the + / - buttons to navigate to the program you want to show or hide from the program selection, then press the OK button. Use the + / - button to switch between the options "on" and "oF". Confirm your selection by pressing the OK button.

on – The program will be visible in the program menu.
oF – The program will be hidden from the program menu

Example:

In the PS menu, use the + / - buttons to navigate to the program EC, then press the OK button. Use the + / - button to switch between "on" and "oF", and confirm your selection by pressing the OK button. The program will now be shown or hidden in the program selection menu depending on your choice.



**Strøm-opptattstatus/
Repower status**

Kort trykk på "M"-knappen og bruk + / - for å navigere til menyvalget "rS". Trykk deretter på "OK" for å gå inn i innstillingene for strøm-opptattstatus.

(LS) - Siste status
(NA) - Manuell modus
(AU) - Automodus
(EC) - Økonomodus
(Fr) - Frostvæskemodus
(P1) - Program 1
(P2) - Program 2
(P3) - Program 3
(P4) - Program 4
(oF) - Avmodus

Naviger til ønsket strøm-opptattstatus med "+" eller "-", og trykk kort på "OK" for å velge ønsket oppførsel. Hvis satt til "Last Status", vil enheten gå tilbake til statusen før strøbruddet når den slås på igjen.

Short press the "M" button and use + / - to navigate to menu option "rS". Then press "OK" to enter the setting of repower status.

(LS) - Last Status
(NA) - Manual Mode
(AU) - Auto mode
(EC) - ECO mode
(Fr) - Anti-freeze mode
(P1) - Program 1
(P2) - Program 2
(P3) - Program 3
(P4) - Program 4
(oF) - Off mode

Navigate to wanted repower status with "+" or "-" and short press "OK" to select wanted behaviour. If set as "last status", device will go to the status before power failure after power on again.



**Systemkontrollmetoder/
System Control Methods**

Kort trykk på "M"- knappen og bruk + / - for å navigere til menyvalget "SC". Trykk deretter på "OK" for å gå inn i innstillingene. Det finnes to metoder som kan konfigureres: "Hy" – Hysterese, "PI" – PID (fabrikkstandard). Naviger til ønsket systemkontrollmetode med "+" eller "-", og trykk kort på "OK" for å velge ønsket oppførsel.

Short press the "M" button and use + / - to navigate to menu option "SC". Then press "OK" to enter the setting. There are two methods can be configured: "Hy"-Hysterisis, "PI"-PID (factory default). Navigate to wanted system control method with "+" or "-" and short press "OK" to select wanted behaviour.

Sikkerhetsmerknad/Safety notice

Sikkerhetsmerknad:

I henhold til IEC 60335-1 Punkt 22.49 - vil apparatet automatisk slå seg av etter 300 dagers kontinuerlig drift. Nedtelling restartes ved strøbrudd eller ved å manuelt sette ovnen i standby-modus direkte på ovnen eller via app.

Safety Notice:

In accordance with IEC 60335-1 Clause 22.49, the appliance will automatically shut off after 300 days of continuous operation. The countdown resets in the event of a power outage or if the oven is manually set to standby-mode, either directly on the device or in the app.

PIN-kodelås/PIN code locking

Etter at PIN-koden er aktivert, kan enheten bare starte i forrige modus, slås av, ingen andre operasjoner kan utføres. For å gjøre andre endringer må PIN-koden angis for å låse opp enheten. Hvis ingen handling utføres innen 10 sekunder etter opplåsing, låses enheten automatisk igjen. PIN-koden kan bestå av mellom 2 til 6 sifre, med en standardverdi på 2 sifre, som er "00".

Aktivere og deaktivere PIN-kode:

Enheden må være i standby-modus (oF). Hold både "M"- og "+"-knappen inne i minst 10 sekunder, det digitale displayet vil vise "Pn" og "n.2" som blinker sakte noen ganger, noe som indikerer at en 2-sifret PIN-kode skal tastes inn. Trykk deretter på "OK"-knappen, displayet vil vise "1.-", som ber deg om å angi det første sifferet i PIN-koden. Bruk "+" eller "-" for å velge sifferet og trykk "OK"-knappen for å bekrefte og gå videre til neste siffer. Fortsett denne prosessen til alle sifre er tastet inn, og "oF" vil vises på displayet. ("on" indikerer at PIN-låsen er aktivert, og "oF" betyr at PIN-låsen er deaktivert.) Du kan veksle mellom "on" og "oF" ved å bruke "+" eller "-" og trykke på "M" for å bekrefte og avslutte. Hvis sifrene tastes inn feil, vil displayet gå direkte ut.

Endre PIN-kode:

I det aktiverte (on) grensesnittet, hold "M"-knappen inne i 5 sekunder for å gå inn i PIN-endringsgrensesnittet, og displayet vil vise "n.2". Trykk kort på "+" eller "-" for å justere antall sifre, trykk deretter kort på "OK" for å gå videre til det nye PIN-inntastingsgrensesnittet, som er "1.-", "2.-", "3.-" osv. Bruk "+" eller "-" for å endre hvert siffer, og trykk kort på "OK" for å bekrefte og lagre hvert siffer.

Opplåsing av driftsgrensesnittet:

Når PIN-koden er aktivert og enheten er låst, trykk kort på "M" eller "+" eller "-". Displayet vil vise "n.2" (som indikerer at en 2-sifret PIN-kode kreves) i noen sekunder. Trykk kort på "OK"-knappen for å angi det første sifferet i PIN-koden. Bruk "+" eller "-" for å justere sifrene. Trykk kort på "OK"-knappen for å gå videre til neste siffer. Hvis sifrene tastes inn feil, vil displayet gå tilbake til "n.2". Trykk kort på "OK"-knappen for å fortsette.

Avslutte grensesnittet:

Når som helst kan du trykke kort på "M"-knappen for å avslutte det aktuelle grensesnittet eller gå tilbake til forrige meny.

Merk:

Hvis du glemmer passordet, og enheten er i PIN-låst tilstand, trykk og hold inne knappen på toppen av kontrollboksen i 3 sekunder for å starte programmet på nytt og gjenopprette PIN-koden til fabrikkens standardverdi (Fig. 1). Et sakte blinkende "PN" på skjermen i 2 sekunder indikerer at det var vellykket. Eller du kan tilbakestille det via appen.

After the PIN code is activated, the device can only start in the previous mode, be turned off, no other operations can be performed. To make other changes, the PIN code must be entered to unlock the device. If no action is taken within 10 seconds after unlocking, the device will automatically re-lock. The PIN code can be between 2 to 6 digits, with a default value of 2 digits which is "00".

Activate and Deactivate the PIN Code:

The device must be in Standby (oF) mode. Press and hold both the "M" and "+" button for at least 10 seconds, the digital display will show "Pn" and "n.2" flashing slowly a few times, indicating that the 2-digit PIN code should be input. And press "OK" button, the display will then show "1.-", prompting you to enter the first digit of the PIN code. Use the "+" or "-" button to select the digit and press the "OK" button to confirm and move to the next digit. Continue this process until all digits are entered, and "oF" will appear on the digital display. ("on" indicates that the PIN lock is activated, and "oF" means the PIN lock is deactivated.) You can switch between "on" and "oF" by using the "+" or "-" buttons and press "M" to confirm and exit. If the digits are entered incorrectly, the display will exit directly.

Modify the PIN Code:

On the activated (on) interface, press and hold the "M" button for 5 seconds to enter the PIN modification interface and the display will show "n.2". Short press the "+" or "-" buttons to adjust the number of digits, then short press the "OK" button to proceed to the new PIN code input interface, which is "1.-", "2.-", "3.-" etc. Use the "+" or "-" buttons to change each digit, and short press the "OK" button to confirm and save each digit.

Unlock Operating interface:

When the PIN code is activated and the device is locked, short press the "M" and "+" and "-" button. The display will show "n.2" (indicating that a 2-digit PIN code is required) for a few seconds, short press "OK" button to enter the first digit of the PIN code. Use the "+" or "-" buttons to adjust the digits. Short press the "OK" button to proceed to the next digit. If the digits are entered incorrectly, the display will return to "n.2". Short press the "OK" button to continue.

Exit the Interface:







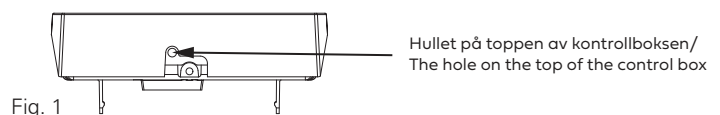

Short press the "M" button to exit the current interface or return to the previous menu.















Note:

If you forget the password, and the device is in the PIN locked state, press and touch the hole on the top of the control box for 3 seconds to restart the program and restore the PIN code to its factory default state (Fig. 1). A slow "PN" flash on the screen for 2 seconds indicates success. Or reset it through the App.



IKONOVERSIKT / ICON OVERVIEW

| | | | |
|--|---|---|---|
|  | Funksjon for åpent vindu deteksjon Windows open detection function |  | Standby Stand by |
|  | KOMFORT modus Comfort mode |  | Temperatur Temperature |
|  | ECO-modus Eco mode |  | Zigbee-nettverkstilkobling Zigbee network connection |
|  | Ikon for varmeindikator Heating indicator icon |  | Time Hour |

| | | | |
|--|---|---|---|
|  | P4 (programmerbart ukesprogram) P4 (free weekly personalized program) |  | Standby-modus. I denne modusen blir ikke apparatet oppvarmet, men klokkeinnstillingene vedlikeholdes. Standby mode. During this mode, the appliance doesn't heat up but clock settings are maintained. |
|  | temperaturkalibrering temperature calibration | | Den valgte funksjonen vil bli deaktivert the selected function will be deactivated |
|  | justering av skjermens lysstyrke adjustment of screen brightness |  | Den valgte funksjonen vil bli aktivert the selected function will be activated |
|  | tilpasningsstartfunksjon adaptive start function |  | fabrikkinnstilling factory default setting |
|  | tidsinnstilling time setting |  | Mandag Monday |
|  | KOMFORT modus Comfort mode |  | Tirsdag Tuesday |
|  | ECO-modus ECO mode |  | Onsdag Wednesday |
|  | Forhåndsinnstilt program P1 fixed pre-set program P1 |  | Torsdag Thursday |
|  | Forhåndsinnstilt program P2 fixed pre-set program P2 |  | Fredag Friday |
|  | Forhåndsinnstilt program P3 fixed pre-set program P3 |  | Lørdag Saturday |
|  | Programmerbart ukesprogram free weekly personalized program |  | Søndag Sunday |
|  | Barnesikring Child Lock |  | Åpent-vindu-funksjon Open window detection |
|  | Koble til Zigbee-nettverket Connect Zigbee network |  | Innstilling av frostbeskyttelsesmodus Anti-freeze mode setting |
|  | Velg om displayet skal være av eller på når du ikke samhandler med enheten Choose if the display should remain on or turn off when you don not interact with the unit. |  | Skjule et programvalg Hide a program selection |
|  | Strøm-oppstartstatus Repower status |  | Systemkontrollmetoder System Control Methods |
|  | OTA-oppgreding OTA Upgrade |  | Hysteresis Hysterisis |

MÅL / MEASURES

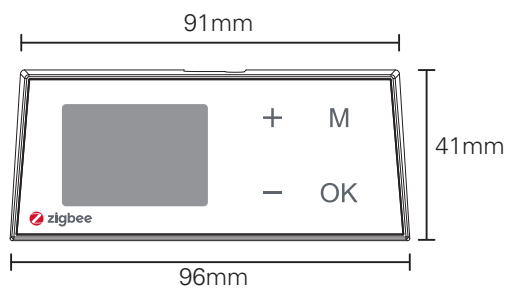

**BRUKSANVISNING
INSTRUCTION MANUAL**

NAMRON PANELOVN WiFi PRO

400W/600W/800W/1000W/1500W/2000W

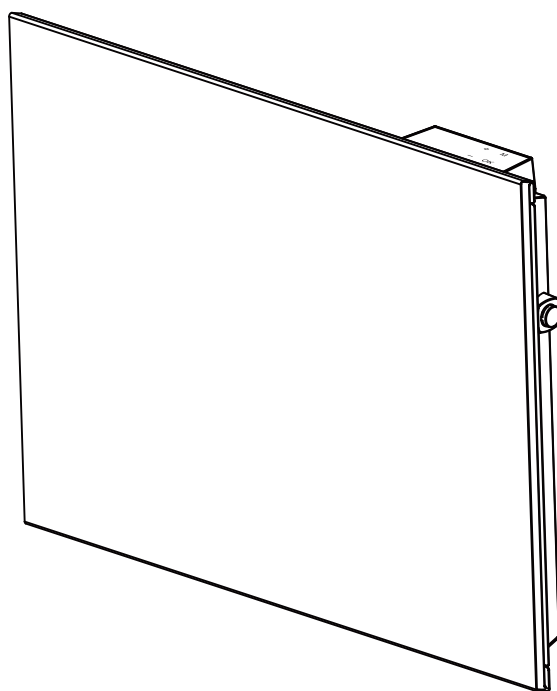

namron
the smarter choice

NAMRON PANELOVN WiFi PRO 400W/600W/800W/1000W/1500W/2000W



220-240V~ 50-60Hz IP24



Effekt: 400W/600W/800W/1000W/1500W/2000W
Spenning: 220-240V~50-60Hz
Tetthetsgrad: IP24
Frekvens: 2.4GHz (2.412-2.472GHz)
RF ledet effekt: 18dBm
Inkludert 1,6 m kabel og støpsel.

Effect: 400W/600W/800W/1000W/1500W/2000W
Operating voltage: 220-240V~50-60Hz
IP Rating: IP24
Frequency: 2.4GHz (2.412-2.472GHz)
RF conducted power: 18dBm
Included 1.6 m cable and plug.

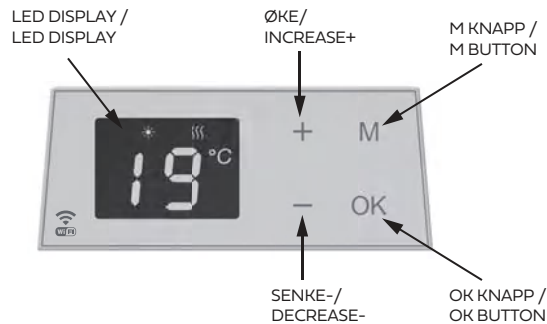
BRUK / USE



BRUK MED WIFI

1. For den innledende oppsettprosessen må Bluetooth og WiFi være aktivert på mobil eller nettbrett. Smart-Life appen lastet ned og brukerkonto opprettet. Velg å legge til ny enhet i appen. (Benytt WiFi-Guiden linket med QR koden under om du er usikker)
2. Sett inn strømpluggen og slå på strømbryteren. Skjermen vil vise temperaturen.
3. Trykk kort på "M"-knappen og benytt + / - for å navigere deg frem til menyvalg "AP". Trykk "OK" knappen for å gå inn i menyen. Trykk deretter på "+" / "-" for å bytte mellom Ad og rE i menyen. Velg "Ad" for å aktivere WiFi-tilkoblingen, WiFi-ikonet  vil forbli tent når nettverkskonfigurasjonen er vellykket. Velg "rE" for å slette den vellykkede WiFi-tilkoblingen, og WiFi-ikonet  vil blinke.
4. Se nedenfor QR-koden for "Wifi-veiledning".



BRUK UTEN WIFI



1. Sett inn strømpluggen og slå på strømbryteren. Skjermen vil vise temperaturen.
2. Velg Komfort modus (viser "FF") eller ECO modus (viser "EE") ved å trykke på "OK"-knappen og holde knappen inne til "FF" eller "EE"-symbolet vises på skjermen.
3. Når omgivelsestemperaturen er lavere enn innstilt temperatur, vil varmeovnen starte oppvarming automatisk. Varmeikonet vil vises på skjermen.
4. Trykk på "+" eller "-" for å stille inn ønsket temperatur. Temperaturen kan justeres mellom 5-35°C. Trykk og hold inne "+" eller "-" for å justere temperaturen raskere.
Fabrikkinnstillingen er KOMFORT = 21 °C, ECO = 17 °C.
5. Trykk "OK" for å velge "FF" for å sette apparatet i standby modus.
6. Trykk på "OK" og velg "FR" for å gå inn i Anti-frostmodus. Temperaturen er fast innstilt på 7 °C og kan ikke justeres.

BRUK MED PROGRAM

1) TIDSINNSTILLING

1. Trykk på "M" knappen og benytt + / - knappene for å navigere deg frem til menyvalg "td". Trykk på "OK" knappen for å gå inn i programmet. Varmeovnen vil gå til menyen for tid.
2. Trykk på "+" / "-" for å stille inn ukedagen (velg fra d1 til d7). Trykk "OK" for å lagre og gå til innstilling for time.
3. Trykk på "+" / "-" for å stille inn timen på dagen (velg fra 0 til 23). Trykk "OK" for å lagre og gå til innstilling for minutt.
4. Trykk på "+" / "-" for å stille inn minuttene (velg fra 00 til 59). Trykk "OK" for å lagre.
Varmeovnen vil gå tilbake til arbeidsmodus og temperaturinnstillingen.

USE WITH WIFI

1. For the initial setup process, Bluetooth and WiFi must be enabled on your mobile or tablet. Smart-Life app downloaded and user account created. Select to add a new device in the app. (Use the WiFi Guide linked with the QR code below if you are unsure)
2. Insert the power plug and turn on the power switch. The screen will show the temperature.
3. Short press "M" button and use + / - buttons to navigate to menu option "AP". Press "OK" button to enter menu. Then press "+" / "-" to switch between Ad and rE in the menu. Select "Ad" to enable the WiFi connection, the WiFi icon  will stay lit once the network configuration is successful. Select "rE" can delete the successful WiFi connection, and the WiFi icon  will flash.
4. Refer to below QR code for "Wifi Guide".



WITHOUT WIFI

1. Insert the power plug and turn on the power switch. The display will show the temperature.
2. Choose Comfort mode (display "FF") or ECO mode (display "EE") by pushing the "OK" button, hold the button until "FF" or "EE" symbol on the display.
3. When the environment temperature is below set temperature, the heater will start heating automatically. The heating icon will be shown in the display.
4. Press "+" or "-" to set the desired temperature. The temperature can be adjusted between 5-35°C. Press and hold "+" or "-" to adjust the temperature in a faster speed.
Factory default setting is COMFORT = 21°C; ECO = 17°C.
5. Press "OK" to select "FF" to turn the appliance into standby.
6. Press "OK" and select "FR" to enter anti-freeze mode. The temperature is fixed at 7°C and cannot be adjusted.

USE WITH PROGRAM

1) TIME SETTING

1. Short press the M button and use + / - buttons to navigate to menu option "td". Short press "OK" button to enter setting. The heater will enter Time setting interface.
2. Press "+" / "-" to set the day of the week (choose from d1 to d7). Press "OK" to save and enter hour setting.
3. Press "+" / "-" to set the hour of the day (choose from 0 to 23). Press "OK" to save and enter minute setting.
4. Press "+" / "-" to set the minute (choose from 00 to 59). Press "OK" to save.
The heater will go back to the working mode and temperature.

2) PROGRAMVALG

Trykk kort på OK for å velge P1, P2, P3 eller P4.

P1, P2, P3 forhåndsinnstilt programmodus

1. Trykk kort på OK for å velge P1, P2, P3 .
2. Etter å ha blinket i 5 sekunder, vil skjermen vise innstilt temperatur.

P1, P2 og P3 er forhåndsinnstilte programmer med følgende forhåndsinnstilte programmer:

| | | | | | | | |
|--|--|--|------------|-----------------|------------|--|------------|
| Ukentlige moduser/ Weekly modes | P1 (5-2) | Mandag-Fredag/Monday-Friday | | | | Lørdag-Søndag/Saturday-Sunday | |
| | P2 (6-1) | Mandag-Lørdag/Monday-Saturday | | | | Søndag/Sunday | |
| | P3 (7-0) | Mandag-Søndag/Monday-Sunday | | | | | |
| | P4 (0-7) | | | | | Mandag-Søndag/Monday-Sunday | |
| Innstilling av tid og program/ Time and program setting | Begivenhet/Event | 4 oppvarmingssykluser/4 heating cycles | | | | 2 oppvarmingssykluser/2 heating cycles | |
| | Tidsperiode/ Time period | Komfort/Comfort | Eco | Komfort/Comfort | Eco | Komfort/Comfort | Eco |
| | Tid / Time | 6:00-9:00 | 9:00-16:00 | 16:00-23:00 | 23:00-6:00 | 7:00-23:00 | 23:00-7:00 |
| | Fabrikkinnstilling/ Factory setting | 21°C | 17°C | 21°C | 17°C | 21°C | 17°C |

2)PROGRAM SELECTION

Short press OK to choose P1 or P2 or P3 or P4.

P1 or P2 or P3 pre-set program mode

1. Short press OK to select P1 or P2 or P3.
2. After flashing 5 seconds, the display will show set temperature.

P1,P2,P3 are default program with pre-set program as below:

P4 er et programmerbart ukesprogram

Hvis du ønsker å endre P4-programmet, følger du trinnene nedenfor:

1. Trykk på "M" knappen og benytt + / - knappene for å navigere deg frem til menyvalg Pr.
2. Trykk OK-knappen for å gå inn i P4-programmet.
3. Etter å ha kommet inn i P4-programmet:

Trinn 1, sett ukedagen, skjermen viser d1, trykk + eller - for å velge d1/d2/d3/d4/d5/d6/d7. Trykk OK-knappen for å bekrefte.

Trinn 2, sett timen på dagen, skjermen viser 0H, trykk + eller - for å velge KOMFORT eller ECO. Trykk OK-knappen for å bekrefte.

KOMFORT modusen fungerer ved KOMFORT modusens temperatur.

ECO modusen fungerer ved ECO modusens temperatur.

Du kan endre temperaturen for KOMFORT og ECO ved å følge trinnene i BRUK UTEN WIFI" Nr. 2.

4. Gjenta de ovennevnte trinnene for å stille inn de gjenværende dagene og timene i uken. Trykk OK for å bekrefte. Skjermen vil blinke i 30 sekunder, og deretter gå tilbake til Pr-programmet. Pr-programmet vil blinke i 10 sekunder. Dette betyr at innstillingen er fullført. Varmeovnen vil følge programmet du har satt.

*Kontroll av hele programmet du har satt

Trykk på "M" knappen og benytt + / - knappene for å navigere deg frem til menyvalg Pr. Trykk "OK" knappen for å velge innstillingen, trykk og hold inne + og - knappen samtidig i 5 sekunder, skjermen vil rulle ut hele ukens program du har satt. Etter det vil den returnere til td-grensesnittet og blinke i 10 sekunder. Deretter vil varmeovnen gå tilbake til arbeidsmodus.

P4 is a Customized weekly program

If you want to revise the P4 program, follow below steps:

1. Short press the M button and use + / - buttons to navigate to menu option "Pr".
2. Press OK button enter P4 interface.
3. After entering P4 interface:

Step 1, set day of the week, display show d1, press + or - choose d1/d2/d3/d4/d5/d6/d7.Press OK button to confirm.

Step 2, set the hour of the day, display show 0H, press + or - choose COMFORT or ECO . Press OK button to confirm.

The Comfort mode works at the temperature of Comfort mode.

The ECO mode works at the temperature of ECO mode.

You can change the temperature of Comfort and ECO following steps in Use without wifi" No.2.

4. Repeat above steps to set the rest day and hours of the week. Press OK to confirm. Display will flash 30s and then back to the interface of Pr. Pr interface will flash 10s. It means the setting is complete. The heater will work the program you have set.

*Checking of the whole program that you have set

Short press the M button and use + / - buttons to navigate to menu option "Pr". Short press the "OK" button to enter setting, press and hold + and - button at the same time for 5s, the display will roll out with the whole week program you have set. After that, it will return to td interface and flash 10s. Then heater will be back to working mode.



Kalibrere temperaturløser / Temperature calibration

Trykk på "M" knappen og benytt + / - for å navigere deg frem til menyvalg "C". Trykk kort på "OK" for å gå inn i C - menyen for kalibrering av temperaturløser. "0" vil vises som standard på skjermen. Trykk på "+" / "-" for å stille inn kompensasjonstemperaturen innenfor $\pm 5^{\circ}\text{C}$.

Short press the "M" button and use + / - to navigate to menu option "C". Short press "OK" to enter C — temperature calibration setting interface. "0" will show on the display as default. Press "+" / "-" to set the compensation temperature within $\pm 5^{\circ}\text{C}$.



Adaptiv start/ Adaptive start

Trykk på "M" knappen og benytt + / - for å navigere deg frem til menyvalg "AS". Trykk "OK" for å gå inn i menyen for adaptiv start. Skjermen vil vise "on" eller "oF". Trykk på "+" eller "-" for å endre valget. Når "on" er valgt, er Adaptiv start aktivert. Når "oF" er valgt, er funksjonen deaktivert. Standardinnstillingen er "oF".

Denne funksjonen beregner hvor lang tid det tar å oppnå ønsket temperatur og aktiverer varmeovnen i god tid for å sikre at "komfort"-temperaturen nås til oppgitt tidspunkt.

Funksjonen kan slå på apparatet for oppvarming maksimalt 2 timer på forhånd.











Merk: Denne funksjonen gjelder bare for P1, P2, P3-programmet.

Short press the "M" button and use + / - to navigate to menu option "AS".

Press "OK" to enter Adaptive Start setting interface. The screen will show "on" or "oF". Press "+" or "-" to change the selection. When "on" is selected, the Adaptive Start function is activated. When "oF" is selected, the function is deactivated. Default setting is "oF".

This feature measures the thermal inertia of the room and turns on the heaters in advance to ensure "comfort" temperature is reached at the set time. This function can turn on the appliance for heating maximum 2 hours in advance.

Remarks: This function applies for P1, P2, P3 program only.

| | |
|--|--|
| <p>Minnefunksjon/ Memory function</p> | <p>Etter strømavbrudd kan varmeovnen huske den innstilte temperaturen før strømbruddet og fortsette å fungere. Ved et strømbrudd vil varmeovnen opprettholde den interne klokken i 24 timer. Hvis strømmen er brutt i mer enn 24 timer, vil varmeovnen, når strømmen slås på igjen, gå tilbake til den sist brukte temperaturen, den interne klokken vil tilbakestilles til standardtid, og varmeovnen vil starte på nytt. Strømbrudd vil bli indikert av at skjermen blinker. Blinkingen vil fortsette til hvilken som helst av knappene trykkes på for å stoppe den.</p> <p>After the power is turned off, the heater can memorize the working set temperature before the power failure and continue to work. In the event of a power disconnection, the heater will keep the internal clock running for 24 hours. If the power is disconnected for more than 24 hours, when the power is turned on again, the heater will return to the last used temperature, the internal clock will return to the default time and start running again. The screen will flash, indicating that there is a power outage. The blinking state will continue until any button is pressed to cancel the blinking.</p> |
| <p> Justering av skjermens lysstyrke/ Adjustment of display brightness</p> | <p>Trykk på "M" knappen og benytt + / - for å navigere deg frem til menyvalg "dL". Trykk "OK" for å gå inn i dL - innstillingsgrensesnittet for skjermlysstyrke. Du kan justere lysstyrken på skjermen. Standardinnstillingen er 3.</p> <p>Trykk på "+" / "-" for å velge mellom nivå 1 til 5. Nivå 1 er den mørkeste, mens 5 er den lyseste.</p> <p>Short press the "M" button and use + / - to navigate to menu option "dL". Press "OK" to enter dL—screen brightness setting interface. You can adjust the brightness of the screen. The default setting value is 3.</p> <p>Press "+" / "-" to choose from grade 1 to 5. Grade 1 is the darkest while 5 is the brightest.</p> |
| <p> Åpent-vindu-funksjon / Open window detection</p> | <p>Trykk på "M" knappen og benytt + / - for å navigere deg frem til menyvalg "Ud". Trykk "OK" for å gå inn i "Ud" – åpent vindusdeteksjonsinnstilling. Åpent-vindu-ikonet  vil da blinke. Trykk deretter på "+" / "-" for å velge «Av» eller «På». Trykk "OK" eller vent i femsekunder uten å trykke på noen knapper for å bekrefte innstillingen. Standardinnstillingen for denne funksjonen er Av. Når funksjonen er aktivert vil Åpent-vindu-ikonet  vises i displayet. Detekterer ovnen et temperaturfall, vil den automatisk gå over i antifrost-modus og operere på 7°C mens Åpent-vindu-ikonet  blinker. Om temperaturen stiger vil ovnen gå tilbake til forrige modus med Åpent-vindu-funksjonen på. Du kan også gå tilbake til forrige modus ved å trykke på en vilkårlig knapp. Velg «Av» for å deaktivere Åpent-vindu-funksjonen.</p> <p>Short press the "M" button and use + / - to navigate to menu option "Ud". Press "OK" to enter "Ud"—open window detection setting. The open window icon  will be flashing. Then press "+" / "-" to choose «on» or «oF». Press "OK" or after five seconds without operating the display, and the setting will be saved. The default factory setting for this function is oF.</p> <p>If «on» is selected, the window detection function is activated and the open window icon  will be visible in the display. When temperature drop is detected, the appliance will automatically enter anti-freeze mode (heater works at 7°C, with open window icon  flashing).</p> <p>If temperature rises, the appliance will go back to previous working mode. You can also press any button to go back to previous mode. Choose «oF» to deactivate the detection function.</p> |
| <p> Barnesikring / Child Lock</p> | <p>Trykk på "M" knappen og benytt + / - for å navigere deg frem til menyvalg "CL". Trykk "OK" for å gå inn i "CL"—barnesikringsinnstilling. Trykk deretter "+" / "-" for å velge «on» eller «oF». Du kan velge «on» og trykke kort på «OK» for å aktivere barnesikringen, og CL vil blinke tre ganger sakte. Velg «oF» og trykk kort på "OK" for å deaktivere barnesikringen, CL vil blinke tre ganger og deretter gå tilbake til hovedgrensesnittet. Barnesikring kan også aktiveres/deaktiveres ved å holde inne "+" og "-" i 5 sekunder.</p> <p>Short press the "M" button and use + / - to navigate to menu option "CL". Press "OK" to enter "CL"—child lock setting. Then press "+" / "-" to choose «on» or «oF». You can choose «on» and short press "OK" to activate the child lock, and CL will flash three times slowly. Choose «oF» and short press "OK" to deactivate the child lock, CL will flash three times and then return to the main interface. Child lock can also be activated / deactivated by holding "+" and "-" for 5 seconds.</p> |
| <p> Tilbakestill til standardinnstilling / Reset the thermostat to default</p> | <p>Trykk på "M" knappen og benytt + / - for å navigere deg frem til menyvalg "rE". Etter å ha trykket "OK" for å bekrefte, viser displayet "rE". Fortsett å holde "OK" i 3 sekunder for å bekrefte tilbakestillingen, panelovnen vil bli satt tilbake til fabrikkinnstillingen. Eller trykk kort på "M" for å gå tilbake til hovedmenyen og avbryte tilbakestillingen.</p> <p>Short press the "M" button and use + / - to navigate to menu option "rE". After pressing "OK" to confirm, the display shows "rE". Keep holding "OK" for 3 seconds to confirm the reset, heater will be set back to the factory default setting. Or short press "M" to return to the main menu and cancel the reset.</p> |
| <p> Skru Av/På lyset i displayet / Light on /off the display</p> | <p>Trykk på "M" knappen og benytt + / - for å navigere deg frem til menyvalg "dA". Trykk deretter "OK" for å gå inn i innstillingen. Trykk kort på "+" / "-" for å velge «on» eller «oF», og trykk "OK" igjen for å bekrefte. Hvis «on» er valgt, aktiveres den automatiske skjermav-funksjonen, displaylyset vil slå seg av etter 30 sekunder uten å bli betjent. Trykk på en hvilken som helst tast for å tenne den igjen.</p> <p>Short press the "M" button and use + / - to navigate to menu option "dA". Then Press "OK" to enter the setting. Short press "+" / "-" to choose «on» or «oF», and press "OK" again to confirm. If «on» is selected, the automatic screen-off function is activated, the display light will turn off after 30 seconds without being operated. Press any key to light it again.</p> |

| | |
|---|---|
|  <p>Skjule eller vies et program i programmenyen /Hide or show a program fin the program selector</p> | <p>Trykk på "M" knappen og benytt + / - for å navigere deg frem til menyvalg "PS". Trykk "OK" knappen for å gå inn i innstillingen. Benytt + / - knappene for å navigere deg frem til programmet du ønsker å vise eller skjule, trykk deretter på OK knappen. Benytt + / - knappen for å skifte mellom valget "on" og "oF". Bekreft valget med å trykke på OK knappen.</p> <p>"on" - Programmet vises i programmenyen "oF" - Programmet skjules i programmenyen</p> <p>Eksempel: I PS menyen, benytt + / - knappene for å navigere deg frem til programmet EC, trykk deretter på OK knappen. Benytt + / - knappen for å skifte mellom valget "on" og "oF". Bekreft valget med å trykke på OK knappen. Programvalget vil nå vises eller skjules i programmenyen avhengig av valg.</p> <p>Short press the "M" button and use + / - to navigate to menu option "PS". Press "OK" button to enter the setting. Use the + / - buttons to navigate to the program you want to show or hide from the program selection, then press the OK button. Use the + / - button to switch between the options "on" and "oF". Confirm your selection by pressing the OK button.</p> <p>on – The program will be visible in the program menu. oF – The program will be hidden from the program menu</p> <p>Example: In the PS menu, use the + / - buttons to navigate to the program EC, then press the OK button. Use the + / - button to switch between "on" and "oF", and confirm your selection by pressing the OK button. The program will now be shown or hidden in the program selection menu depending on your choice.</p> |
| <p>Informasjon før førstegangs bruk / Information before first time use</p> | <p>Ovnen bør settes på maksimal temperatur i 30 minutter for å brenne elementet rent. Noe lukt kan oppstå når dette gjøres!</p> <p>The heater should be set to maximal temperature for 30 minutes to burn the element clean. Some smell may occur.</p> |
| <p>Sikkerhetsmerknad/Safety notice</p> | <p>Sikkerhetsmerknad: I henhold til IEC 60335-1 Punkt 22.49 - vil apparatet automatisk slå seg av etter 300 dagers kontinuerlig drift. Nedtelling restartes ved strømbrytning eller ved å manuelt sette ovnen i standby-modus direkte på ovnen eller via app.</p> <p>Safety Notice: In accordance with IEC 60335-1 Clause 22.49, the appliance will automatically shut off after 300 days of continuous operation. The countdown resets in the event of a power outage or if the oven is manually set to standby-mode, either directly on the device or in the app.</p> |











**MÅ IKKE TILDEKKES/
DO NOT COVER**















SIKKERHET/SAFETY

Må ikke tildekkes, ovnens overflate kan bli svært varm og må plasseres i trygg avstand fra brennbart materiale. Koble fra strømmen ved vedlikehold. Ved bruk av skjøteledning må den være kortest mulig og rullet ut når ovnen er på.

Do not cover the heater surface, the heater can become very hot and must be placed at a safe distance from flammable material. Disconnect power during maintenance. If using an extension cord it must be as short as possible and be extended when the oven is on.

IKONOVERSIKT / ICON OVERVIEW

| | | | |
|--|---|---|---------------------------|
|  | Funksjon for åpent vindu deteksjon Windows open detection function |  | Standby Stand by |
|  | KOMFORT modus Comfort mode |  | Temperatur Temperature |
|  | ECO-modus Eco mode |  | Wi-Fi Wi-Fi |
|  | Ikon for varmeindikator Heating indicator icon |  | Time Hour |

| | | | |
|--|--|---|---|
|  | P4 (programmerbart ukesprogram) P4 (free weekly personalized program) |  | Standby-modus. I denne modusen blir ikke apparatet oppvarmet, men klokkeinnstillingene vedlikeholdes. Standby mode. During this mode, the appliance doesn't heat up but clock settings are maintained. |
|  | temperaturkalibrering temperature calibration |  | Den valgte funksjonen vil bli deaktivert the selected function will be deactivated |
|  | justering av skjermens lysstyrke adjustment of screen brightness |  | Den valgte funksjonen vil bli aktivert the selected function will be activated |
|  | tilpasningsstartfunksjon adaptive start function |  | fabrikkinnstilling factory default setting |
|  | tidsinnstilling time setting |  | Mandag Monday |
|  | KOMFORT modus Comfort mode |  | Tirsdag Tuesday |
|  | ECO-modus ECO mode |  | Onsdag Wednesday |
|  | Forhåndsinnstilt program P1 fixed pre-set program P1 |  | Torsdag Thursday |
|  | Forhåndsinnstilt program P2 fixed pre-set program P2 |  | Fredag Friday |
|  | Forhåndsinnstilt program P3 fixed pre-set program P3 |  | Lørdag Saturday |
|  | Programmerbart ukesprogram free weekly personalized program |  | Søndag Sunday |
|  | Barnesikring Child Lock |  | Åpent-vindu-funksjon Open window detection |
|  | WiFi-tilkoblingen WiFi connection |  | Innstilling av frostbeskyttelsesmodus Anti-freeze mode setting |
|  | Velg om displayet skal være av eller på når du ikke samhandler med enheten Choose if the display should remain on or turn off when you do not interact with the unit. |  | Skjule et programvalg Hide a program selection |

MONTERING AV OVNEN/ASSEMBLY OF THE HEATER

- 1) Bor hull i vegg. Avstand mellom hull: Se skjema (a).
- 2) Skru fast festet på vegg.
- 3) Press ovnen på festet og skru fast.

- 1) Drill holes in the wall. Distance between holes: See the form (a).
- 2) Attach the clips onto the wall.
- 3) Push the heater into the clips and use screws to thighten the clips.

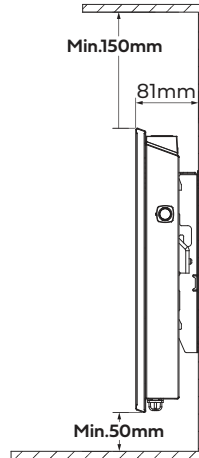
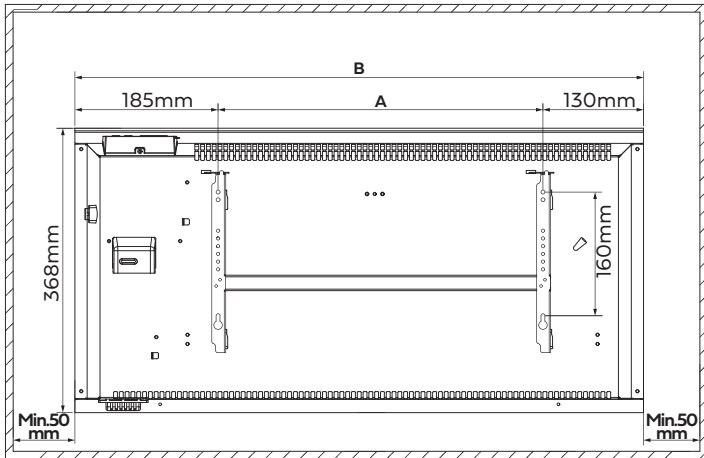

(mm)

| Watt | A | B |
|-------|-----|------|
| 400W | 150 | 465 |
| 600W | 210 | 525 |
| 800W | 330 | 645 |
| 1000W | 420 | 735 |
| 1500W | 420 | 945 |
| 2000W | 490 | 1155 |

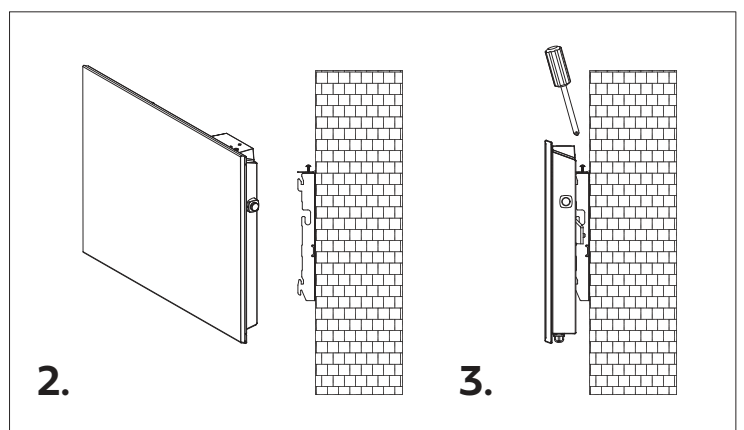
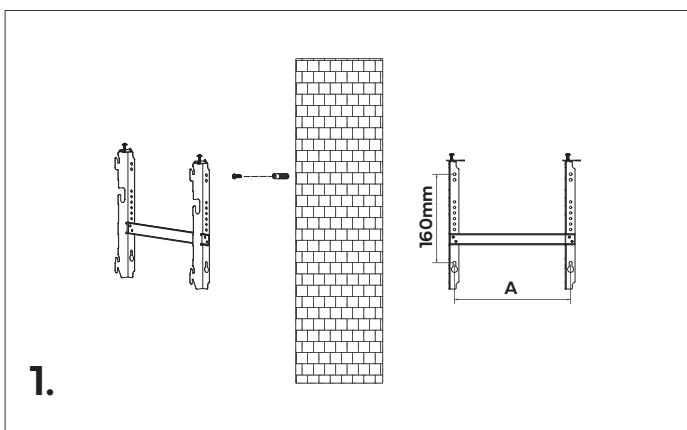
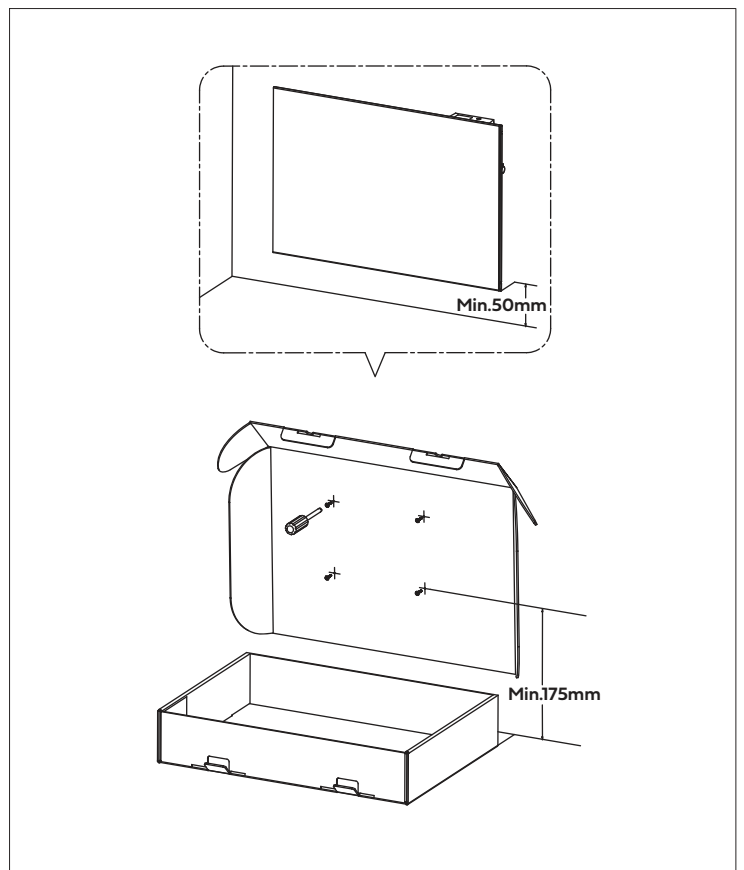
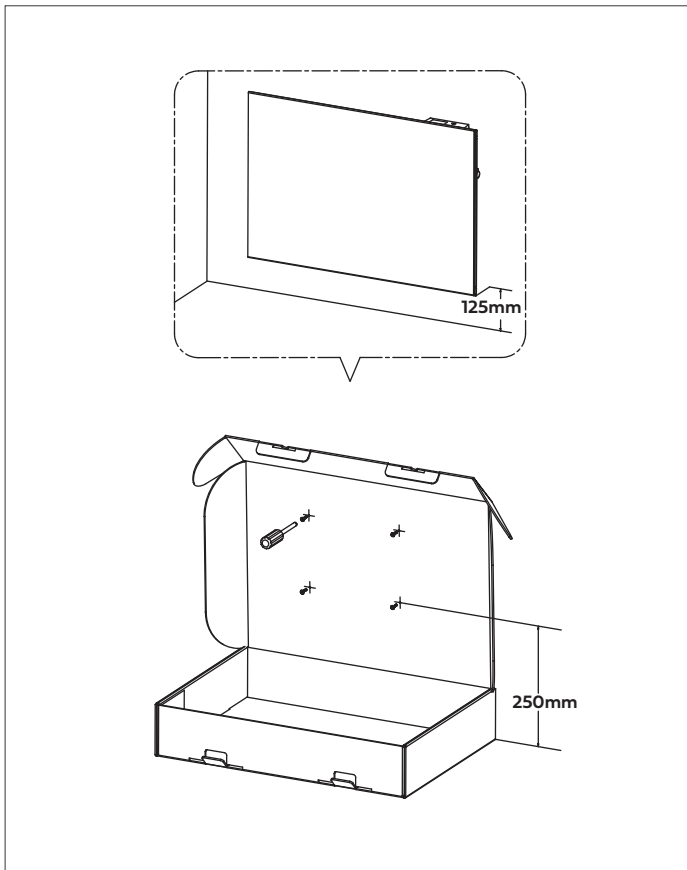

MÅL / MEASURES

400W

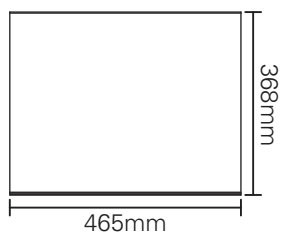

600W

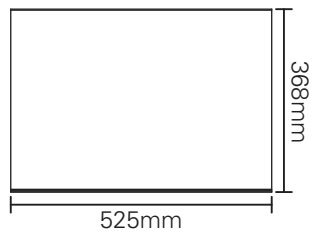

800W

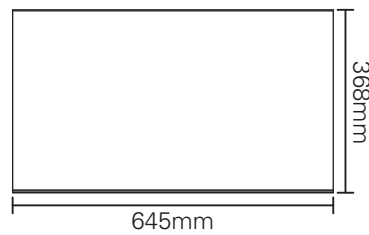

1000W

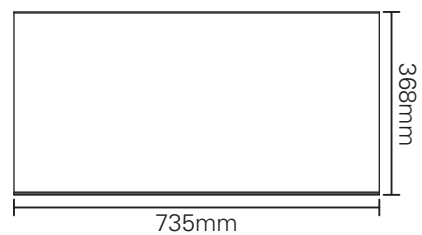

1500W

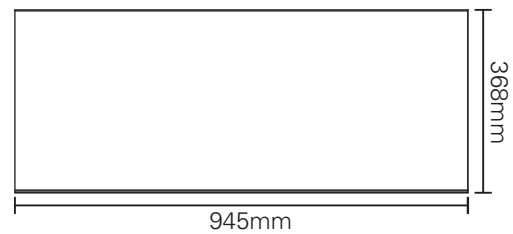

2000W

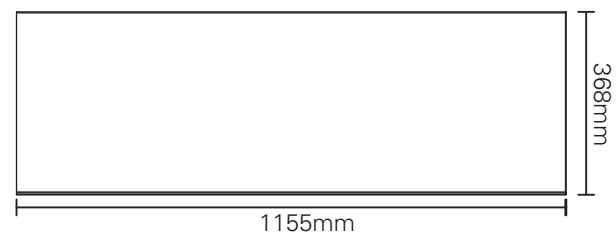

| Model identifier(s): 5419635,5419636 | | | | | | |
|--|--|---------|------|--|---|-------|
| Item | Symbol | Value | Unit | | Item | Unit |
| Heat output | | | | | Type of heat input, for electric storage local space heaters only (select one) | |
| Nominal heat output | P_{nom} | 0.400 | kW | | manual heat charge control, with integrated thermostat | [no] |
| Minimum heat output (indicative) | P_{min} | N/A | kW | | manual heat charge control with room and/or outdoor temperature feedback | [no] |
| Maximum continuous heat output | $P_{max,c}$ | 0.400 | kW | | electronic heat charge control with room and/or outdoor temperature feedback | [no] |
| Auxiliary electricity consumption | | | | | fan assisted heat output | [no] |
| At nominal heat output | eI_{max} | 0.000 | kW | | Type of heat output/room temperature control (select one) | |
| At minimum heat output | eI_{min} | 0.000 | kW | | single stage heat output and no room temperature control | [no] |
| In standby mode | eI_{SB} | 0.00046 | kW | | Two or more manual stages, no room temperature control | [no] |
| | | | | | with mechanic thermostat room temperature control | [no] |
| | | | | | with electronic room temperature control | [no] |
| | | | | | electronic room temperature control plus day timer | [no] |
| | | | | | electronic room temperature control plus week timer | [yes] |
| | | | | | Other control options (multiple selections possible) | |
| | | | | | room temperature control, with presence detection | [no] |
| | | | | | room temperature control, with open window detection | [yes] |
| | | | | | with distance control option | [yes] |
| | | | | | with adaptive start control | [no] |
| | | | | | with working time limitation | [no] |
| | | | | | with black bulb sensor | [no] |
| Contact details | Namron AS Nedre kalbakkvei 88 1081 Oslo Norway post@namron.com | | | | | |

| Model identifier(s): 5419637,5419638 | | | | | |
|--|--|---------|------|---|-------|
| Item | Symbol | Value | Unit | Item | Unit |
| Heat output | | | | Type of heat input, for electric storage local space heaters only (select one) | |
| Nominal heat output | P_{nom} | 0.600 | kW | manual heat charge control, with integrated thermostat | [no] |
| Minimum heat output (indicative) | P_{min} | N/A | kW | manual heat charge control with room and/or outdoor temperature feedback | [no] |
| Maximum continuous heat output | $P_{max,c}$ | 0.600 | kW | electronic heat charge control with room and/or outdoor temperature feedback | [no] |
| Auxiliary electricity consumption | | | | fan assisted heat output | [no] |
| At nominal heat output | e_{lmax} | 0.000 | kW | Type of heat output/room temperature control (select one) | |
| At minimum heat output | e_{lmin} | 0.000 | kW | single stage heat output and no room temperature control | [no] |
| In standby mode | e_{lSB} | 0.00046 | kW | Two or more manual stages, no room temperature control | [no] |
| | | | | with mechanic thermostat room temperature control | [no] |
| | | | | with electronic room temperature control | [no] |
| | | | | electronic room temperature control plus day timer | [no] |
| | | | | electronic room temperature control plus week timer | [yes] |
| | | | | Other control options (multiple selections possible) | |
| | | | | room temperature control, with presence detection | [no] |
| | | | | room temperature control, with open window detection | [yes] |
| | | | | with distance control option | [yes] |
| | | | | with adaptive start control | [no] |
| | | | | with working time limitation | [no] |
| | | | | with black bulb sensor | [no] |
| Contact details | Namron AS Nedre kalbakkvei 88 1081 Oslo Norway post@namron.com | | | | |

| Model identifier(s): 5419639,5419640 | | | | | |
|--|--|---------|------|---|-------|
| Item | Symbol | Value | Unit | Item | Unit |
| Heat output | | | | Type of heat input, for electric storage local space heaters only (select one) | |
| Nominal heat output | P_{nom} | 0.800 | kW | manual heat charge control, with integrated thermostat | [no] |
| Minimum heat output (indicative) | P_{min} | N/A | kW | manual heat charge control with room and/or outdoor temperature feedback | [no] |
| Maximum continuous heat output | $P_{max,c}$ | 0.800 | kW | electronic heat charge control with room and/or outdoor temperature feedback | [no] |
| Auxiliary electricity consumption | | | | fan assisted heat output | |
| At nominal heat output | e_{lmax} | 0.000 | kW | Type of heat output/room temperature control (select one) | |
| At minimum heat output | e_{lmin} | 0.000 | kW | single stage heat output and no room temperature control | [no] |
| In standby mode | e_{lSB} | 0.00046 | kW | Two or more manual stages, no room temperature control | [no] |
| | | | | with mechanic thermostat room temperature control | [no] |
| | | | | with electronic room temperature control | [no] |
| | | | | electronic room temperature control plus day timer | [no] |
| | | | | electronic room temperature control plus week timer | [yes] |
| | | | | Other control options (multiple selections possible) | |
| | | | | room temperature control, with presence detection | [no] |
| | | | | room temperature control, with open window detection | [yes] |
| | | | | with distance control option | [yes] |
| | | | | with adaptive start control | [no] |
| | | | | with working time limitation | [no] |
| | | | | with black bulb sensor | [no] |
| Contact details | Namron AS Nedre kalbakkvei 88 1081 Oslo Norway post@namron.com | | | | |

| Model identifier(s): 5419641,5419642 | | | | | |
|--|--|---------|------|---|-------|
| Item | Symbol | Value | Unit | Item | Unit |
| Heat output | | | | Type of heat input, for electric storage local space heaters only (select one) | |
| Nominal heat output | P_{nom} | 1.000 | kW | manual heat charge control, with integrated thermostat | [no] |
| Minimum heat output (indicative) | P_{min} | N/A | kW | manual heat charge control with room and/or outdoor temperature feedback | [no] |
| Maximum continuous heat output | $P_{max,c}$ | 1.000 | kW | electronic heat charge control with room and/or outdoor temperature feedback | [no] |
| Auxiliary electricity consumption | | | | fan assisted heat output | |
| At nominal heat output | e_{lmax} | 0.000 | kW | Type of heat output/room temperature control (select one) | |
| At minimum heat output | e_{lmin} | 0.000 | kW | single stage heat output and no room temperature control | [no] |
| In standby mode | e_{lSB} | 0.00046 | kW | Two or more manual stages, no room temperature control | [no] |
| | | | | with mechanic thermostat room temperature control | [no] |
| | | | | with electronic room temperature control | [no] |
| | | | | electronic room temperature control plus day timer | [no] |
| | | | | electronic room temperature control plus week timer | [yes] |
| | | | | Other control options (multiple selections possible) | |
| | | | | room temperature control, with presence detection | [no] |
| | | | | room temperature control, with open window detection | [yes] |
| | | | | with distance control option | [yes] |
| | | | | with adaptive start control | [no] |
| | | | | with working time limitation | [no] |
| | | | | with black bulb sensor | [no] |
| Contact details | Namron AS Nedre kalbakkvei 88 1081 Oslo Norway post@namron.com | | | | |

| Model identifier(s): 5419643, 5419644 | | | | | | |
|--|--|---------|------|--|---|-------|
| Item | Symbol | Value | Unit | | Item | Unit |
| Heat output | | | | | Type of heat input, for electric storage local space heaters only (select one) | |
| Nominal heat output | P_{nom} | 1.500 | kW | | manual heat charge control, with integrated thermostat | [no] |
| Minimum heat output (indicative) | P_{min} | N/A | kW | | manual heat charge control with room and/or outdoor temperature feedback | [no] |
| Maximum continuous heat output | $P_{max,c}$ | 1.500 | kW | | electronic heat charge control with room and/or outdoor temperature feedback | [no] |
| Auxiliary electricity consumption | | | | | fan assisted heat output | [no] |
| At nominal heat output | eI_{max} | 0.000 | kW | | Type of heat output/room temperature control (select one) | |
| At minimum heat output | eI_{min} | 0.000 | kW | | single stage heat output and no room temperature control | [no] |
| In standby mode | eI_{SB} | 0.00046 | kW | | Two or more manual stages, no room temperature control | [no] |
| | | | | | with mechanic thermostat room temperature control | [no] |
| | | | | | with electronic room temperature control | [no] |
| | | | | | electronic room temperature control plus day timer | [no] |
| | | | | | electronic room temperature control plus week timer | [yes] |
| | | | | | Other control options (multiple selections possible) | |
| | | | | | room temperature control, with presence detection | [no] |
| | | | | | room temperature control, with open window detection | [yes] |
| | | | | | with distance control option | [yes] |
| | | | | | with adaptive start control | [no] |
| | | | | | with working time limitation | [no] |
| | | | | | with black bulb sensor | [no] |
| Contact details | Namron AS Nedre kalbakkvei 88 1081 Oslo Norway post@namron.com | | | | | |

| Model identifier(s): 5419621,5419622 | | | | | |
|--|--|---------|------|---|-------|
| Item | Symbol | Value | Unit | Item | Unit |
| Heat output | | | | Type of heat input, for electric storage local space heaters only (select one) | |
| Nominal heat output | P_{nom} | 2.000 | kW | manual heat charge control, with integrated thermostat | [no] |
| Minimum heat output (indicative) | P_{min} | N/A | kW | manual heat charge control with room and/or outdoor temperature feedback | [no] |
| Maximum continuous heat output | $P_{max,c}$ | 2.000 | kW | electronic heat charge control with room and/or outdoor temperature feedback | [no] |
| Auxiliary electricity consumption | | | | fan assisted heat output | |
| At nominal heat output | e_{lmax} | 0.000 | kW | Type of heat output/room temperature control (select one) | |
| At minimum heat output | e_{lmin} | 0.000 | kW | single stage heat output and no room temperature control | [no] |
| In standby mode | e_{lSB} | 0.00046 | kW | Two or more manual stages, no room temperature control | [no] |
| | | | | with mechanic thermostat room temperature control | [no] |
| | | | | with electronic room temperature control | [no] |
| | | | | electronic room temperature control plus day timer | [no] |
| | | | | electronic room temperature control plus week timer | [yes] |
| | | | | Other control options (multiple selections possible) | |
| | | | | room temperature control, with presence detection | [no] |
| | | | | room temperature control, with open window detection | [yes] |
| | | | | with distance control option | [yes] |
| | | | | with adaptive start control | [no] |
| | | | | with working time limitation | [no] |
| | | | | with black bulb sensor | [no] |
| Contact details | Namron AS Nedre kalbakkvei 88 1081 Oslo Norway post@namron.com | | | | |

| Model identifier(s): 5419635,5419636 | | | | | |
|---|--|-------|------|--|-------|
| Item | Symbol | Value | Unit | Item | Value |
| Heat output | | | | Type of heat output/room temperature control (select one) | |
| Nominal heat output | P_{nom} | 0.400 | kW | Single stage heat output and no room temperature control | [no] |
| Minimum heat output (indicative) | P_{min} | N/A | kW | Two or more manual stages, no room temperature control | [no] |
| Maximum continuous heat output | $P_{max,c}$ | 0.400 | kW | With mechanic thermostat room temperature control | [no] |
| Power consumption | | | | With electronic room temperature control | [no] |
| In off mode | P_o | 0.00 | W | Electronic room temperature control plus day timer | [no] |
| In standby mode | P_{sm} | 0.46 | W | Electronic room temperature control plus week timer | [yes] |
| In idle mode | P_{idle} | 0.92 | W | Other control options (multiple selections possible) | |
| In network standby | P_{nsm} | 0.90 | W | Room temperature control, with presence detection | [no] |
| Standby mode with display of information or status | | yes | | Room temperature control, with open window detection | [yes] |
| Seasonal space heating energy efficiency in active mode | $\eta_{S,on}$ | 94.0 | % | Distance control option | [yes] |
| | | | | Adaptive start control | [no] |
| | | | | Working time limitation | [no] |
| | | | | Black bulb sensor | [no] |
| | | | | Self-learning functionality | [no] |
| | | | | Control accuracy | [no] |
| Contact details | Namron AS Nedre kalbakkvei 88 1081 Oslo Norway post@namron.com | | | | |

| Model identifier(s): 5419637,5419638 | | | | | |
|---|--|-------|------|--|-------|
| Item | Symbol | Value | Unit | Item | Value |
| Heat output | | | | Type of heat output/room temperature control (select one) | |
| Nominal heat output | P_{nom} | 0.600 | kW | Single stage heat output and no room temperature control | [no] |
| Minimum heat output (indicative) | P_{min} | N/A | kW | Two or more manual stages, no room temperature control | [no] |
| Maximum continuous heat output | $P_{max,c}$ | 0.600 | kW | With mechanic thermostat room temperature control | [no] |
| Power consumption | | | | With electronic room temperature control | [no] |
| In off mode | P_o | 0.00 | W | Electronic room temperature control plus day timer | [no] |
| In standby mode | P_{sm} | 0.46 | W | Electronic room temperature control plus week timer | [yes] |
| In idle mode | P_{idle} | 0.92 | W | Other control options (multiple selections possible) | |
| In network standby | P_{nsm} | 0.90 | W | Room temperature control, with presence detection | [no] |
| Standby mode with display of information or status | | yes | | Room temperature control, with open window detection | [yes] |
| Seasonal space heating energy efficiency in active mode | $\eta_{S,on}$ | 94.0 | % | Distance control option | [yes] |
| | | | | Adaptive start control | [no] |
| | | | | Working time limitation | [no] |
| | | | | Black bulb sensor | [no] |
| | | | | Self-learning functionality | [no] |
| | | | | Control accuracy | [no] |
| Contact details | Namron AS Nedre kalbakkvei 88 1081 Oslo Norway post@namron.com | | | | |

| Model identifier(s): 5419639,5419640 | | | | | |
|---|--|-------|------|--|-------|
| Item | Symbol | Value | Unit | Item | Value |
| Heat output | | | | Type of heat output/room temperature control (select one) | |
| Nominal heat output | P_{nom} | 0.800 | kW | Single stage heat output and no room temperature control | [no] |
| Minimum heat output (indicative) | P_{min} | N/A | kW | Two or more manual stages, no room temperature control | [no] |
| Maximum continuous heat output | $P_{max,c}$ | 0.800 | kW | With mechanic thermostat room temperature control | [no] |
| Power consumption | | | | With electronic room temperature control | [no] |
| In off mode | P_o | 0.00 | W | Electronic room temperature control plus day timer | [no] |
| In standby mode | P_{sm} | 0.46 | W | Electronic room temperature control plus week timer | [yes] |
| In idle mode | P_{idle} | 0.92 | W | Other control options (multiple selections possible) | |
| In network standby | P_{nsm} | 0.90 | W | Room temperature control, with presence detection | [no] |
| Standby mode with display of information or status | | yes | | Room temperature control, with open window detection | [yes] |
| Seasonal space heating energy efficiency in active mode | $\eta_{S,on}$ | 94.0 | % | Distance control option | [yes] |
| | | | | Adaptive start control | [no] |
| | | | | Working time limitation | [no] |
| | | | | Black bulb sensor | [no] |
| | | | | Self-learning functionality | [no] |
| | | | | Control accuracy | [no] |
| Contact details | Namron AS Nedre kalbakkvei 88 1081 Oslo Norway post@namron.com | | | | |

| Model identifier(s): 5419641,5419642 | | | | | |
|---|--|-------|------|--|-------|
| Item | Symbol | Value | Unit | Item | Value |
| Heat output | | | | Type of heat output/room temperature control (select one) | |
| Nominal heat output | P_{nom} | 1.000 | kW | Single stage heat output and no room temperature control | [no] |
| Minimum heat output (indicative) | P_{min} | N/A | kW | Two or more manual stages, no room temperature control | [no] |
| Maximum continuous heat output | $P_{max,c}$ | 1.000 | kW | With mechanic thermostat room temperature control | [no] |
| Power consumption | | | | With electronic room temperature control | |
| In off mode | P_o | 0.00 | W | Electronic room temperature control plus day timer | [no] |
| In standby mode | P_{sm} | 0.46 | W | Electronic room temperature control plus week timer | [yes] |
| In idle mode | P_{idle} | 0.92 | W | Other control options (multiple selections possible) | |
| In network standby | P_{nsm} | 0.90 | W | Room temperature control, with presence detection | [no] |
| Standby mode with display of information or status | | yes | | Room temperature control, with open window detection | [yes] |
| Seasonal space heating energy efficiency in active mode | $\eta_{S,on}$ | 94.0 | % | Distance control option | [yes] |
| | | | | Adaptive start control | [no] |
| | | | | Working time limitation | [no] |
| | | | | Black bulb sensor | [no] |
| | | | | Self-learning functionality | [no] |
| | | | | Control accuracy | [no] |
| Contact details | Namron AS Nedre kalbakkvei 88 1081 Oslo Norway post@namron.com | | | | |

| Model identifier(s): 5419643, 5419644 | | | | | |
|---|--|-------|------|--|-------|
| Item | Symbol | Value | Unit | Item | Value |
| Heat output | | | | Type of heat output/room temperature control (select one) | |
| Nominal heat output | P_{nom} | 1.500 | kW | Single stage heat output and no room temperature control | [no] |
| Minimum heat output (indicative) | P_{min} | N/A | kW | Two or more manual stages, no room temperature control | [no] |
| Maximum continuous heat output | $P_{max,c}$ | 1.500 | kW | With mechanic thermostat room temperature control | [no] |
| Power consumption | | | | With electronic room temperature control | |
| In off mode | P_o | 0.00 | W | Electronic room temperature control plus day timer | [no] |
| In standby mode | P_{sm} | 0.46 | W | Electronic room temperature control plus week timer | [yes] |
| In idle mode | P_{idle} | 0.92 | W | Other control options (multiple selections possible) | |
| In network standby | P_{nsm} | 0.90 | W | Room temperature control, with presence detection | [no] |
| Standby mode with display of information or status | | yes | | Room temperature control, with open window detection | [yes] |
| Seasonal space heating energy efficiency in active mode | $\eta_{S,on}$ | 94.0 | % | Distance control option | [yes] |
| | | | | Adaptive start control | [no] |
| | | | | Working time limitation | [no] |
| | | | | Black bulb sensor | [no] |
| | | | | Self-learning functionality | [no] |
| | | | | Control accuracy | [no] |
| Contact details | Namron AS Nedre kalbakkvei 88 1081 Oslo Norway post@namron.com | | | | |

| Model identifier(s): 5419621,5419622 | | | | | |
|---|--|-------|------|--|-------|
| Item | Symbol | Value | Unit | Item | Value |
| Heat output | | | | Type of heat output/room temperature control (select one) | |
| Nominal heat output | P_{nom} | 2.000 | kW | Single stage heat output and no room temperature control | [no] |
| Minimum heat output (indicative) | P_{min} | N/A | kW | Two or more manual stages, no room temperature control | [no] |
| Maximum continuous heat output | $P_{max,c}$ | 2.000 | kW | With mechanic thermostat room temperature control | [no] |
| Power consumption | | | | With electronic room temperature control | [no] |
| In off mode | P_o | 0.00 | W | Electronic room temperature control plus day timer | [no] |
| In standby mode | P_{sm} | 0.46 | W | Electronic room temperature control plus week timer | [yes] |
| In idle mode | P_{idle} | 0.92 | W | Other control options (multiple selections possible) | |
| In network standby | P_{nsm} | 0.90 | W | Room temperature control, with presence detection | [no] |
| Standby mode with display of information or status | | yes | | Room temperature control, with open window detection | [yes] |
| Seasonal space heating energy efficiency in active mode | $\eta_{S,on}$ | 94.0 | % | Distance control option | [yes] |
| | | | | Adaptive start control | [no] |
| | | | | Working time limitation | [no] |
| | | | | Black bulb sensor | [no] |
| | | | | Self-learning functionality | [no] |
| | | | | Control accuracy | [no] |
| Contact details | Namron AS Nedre kalbakkvei 88 1081 Oslo Norway post@namron.com | | | | |