

**EU**  
**xComfort CTAA-0X/04, CTAA-0X/04-LED**

Assembly instructions  
Montageanweisung  
Instructions de montage  
Montážní návod  
Montážni návod  
Montagevejledning  
Instrucciones de montaje  
Szerelési utasítás  
Istruzioni di montaggio  
Montasje anvisning  
Montage instructie  
Instruções de montagem  
Instrukcja montazu  
Montageanvisning  
Asennusohjeet  
Montaj talimatı  
Instruțiuni de montaj  
Инструкция по монтажу  
οδηγία συναρμολόγησης  
安装说明书  
تعليمات التركيب



Danger  
Lebensgefahr  
Danger de mort  
Nebezpečí  
Nebezpečenstvo  
Fare  
Peligro  
Életveszély  
Pericolo di morte  
Perico  
Levensgevaar  
Perigo  
Niebezpieczeństwo  
Varning  
Vaara  
Hayati Tehlike  
Pericol  
Опасность  
κίνδυνος θανάτου  
危險  
خطر على الحياة



Installation by electricians only  
Montage nur durch Elektrofachkräfte  
Montage uniquement par un électricien  
Montáž pouze osobami s elektrotechnickou kvalifikací  
Montáž iba osobami s elektrotechnickou kvalifikáciou  
Må kun installeres af en aut. el-installatør  
Debe ser instalado por un profesional eléctrico  
Csak szakképzett személy szerelheti  
Montaggio esclusivamente ad opera di personale specializzato  
Må monteres av autorisert installatør Gr.L  
Montage alleen door elektromonteurs  
Deve ser instalado por um profissional  
Montaz tylko przez uprawnionych instalatorów  
Får endast utföras av behörig elektriker  
Asennus vain sähköasentajan toimesta  
Sadece uzman kisiler monte edebilir  
Instalare numai de catre electricieni  
Монтаж может производить только электрик  
Εγκατάσταση μόνο από ηλεκτρολόγους  
仅允许合格电气技师进行安装  
التركيب فقط من قبل عمال كهرباء اختصاصيين

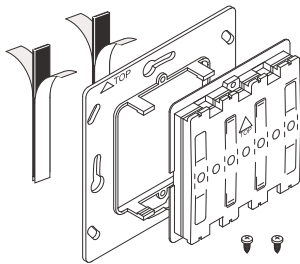

CTAA-01/04  
CTAA-01/04-LED

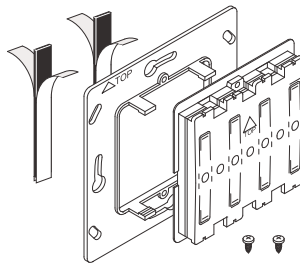

CTAA-02/04  
CTAA-02/04-LED

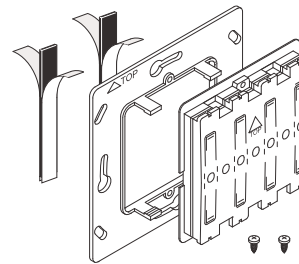

CTAA-04/04  
CTAA-04/04-LED

**CWIZ-0X/0X**

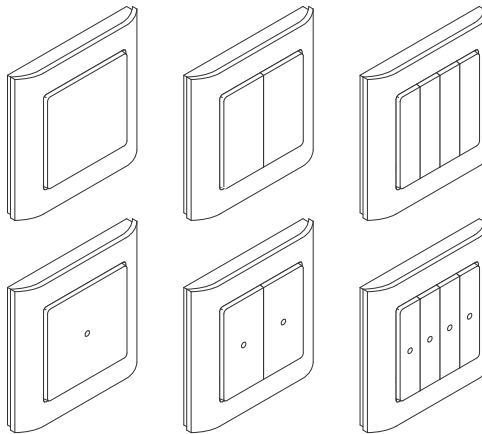
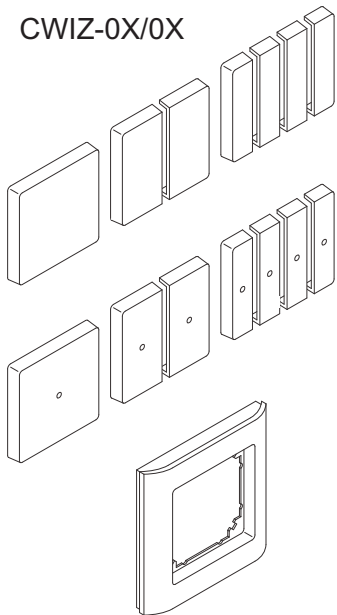

	Min. Version 1.53
	Min. Version 3.5

	T=-25°C - +70°C
	T=+5°C - +40°C

**IP20**

Merten	Gira	Busch Jaeger	Jung	Berker	Siemens	Elko	Kopp
1-M	Standard 55	Carat*	AS	S.1	Delta line	RS16	Alaska
Atelier M	E2	Pur Edelmetall*	A 500	B.1	Delta vita	Plus	
M-Smart	Event	Solo*	A plus	B.3	Delta miro		
M-Arc	Esprit	Future*	A creation	B.7 Glas	Delta profil**		
M-Star	Profil 55	Future linear*					
M-Plan	E22	CZ Future*					
M-Plan II							
M-Plan Metall							
M-Plan Glas							

\* only with intermediate frame Busch&Jäger  
\*\* only with intermediate frame Siemens

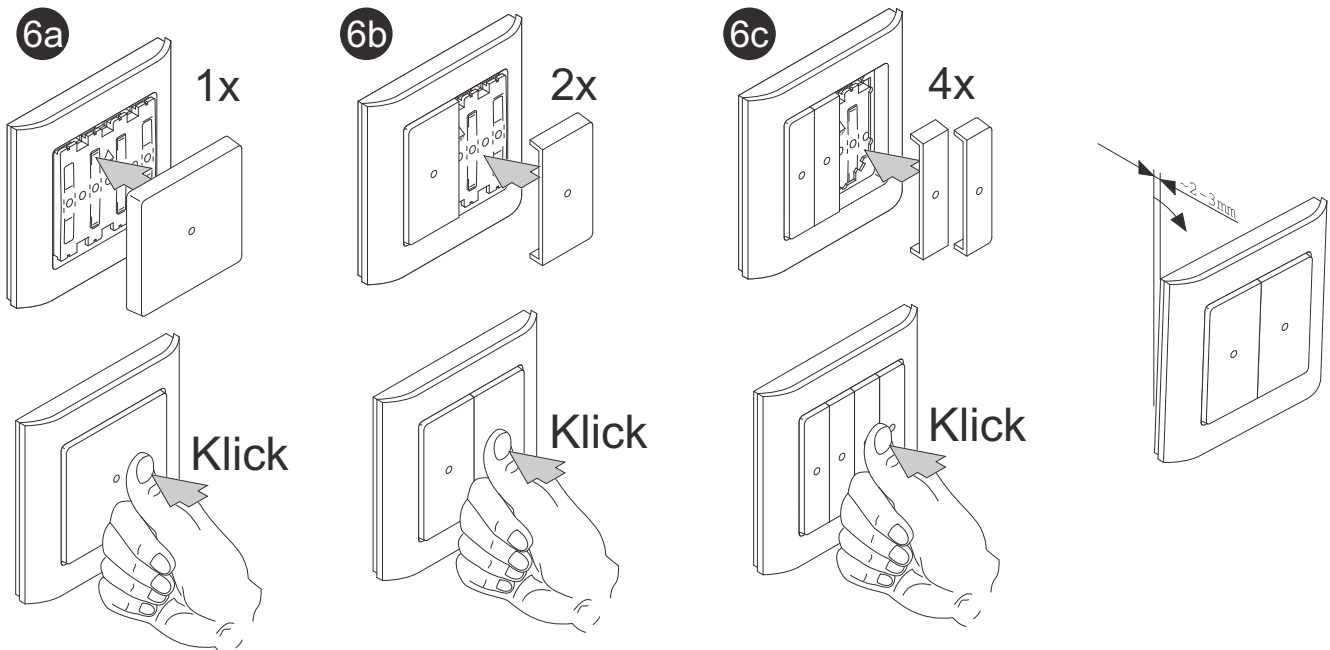
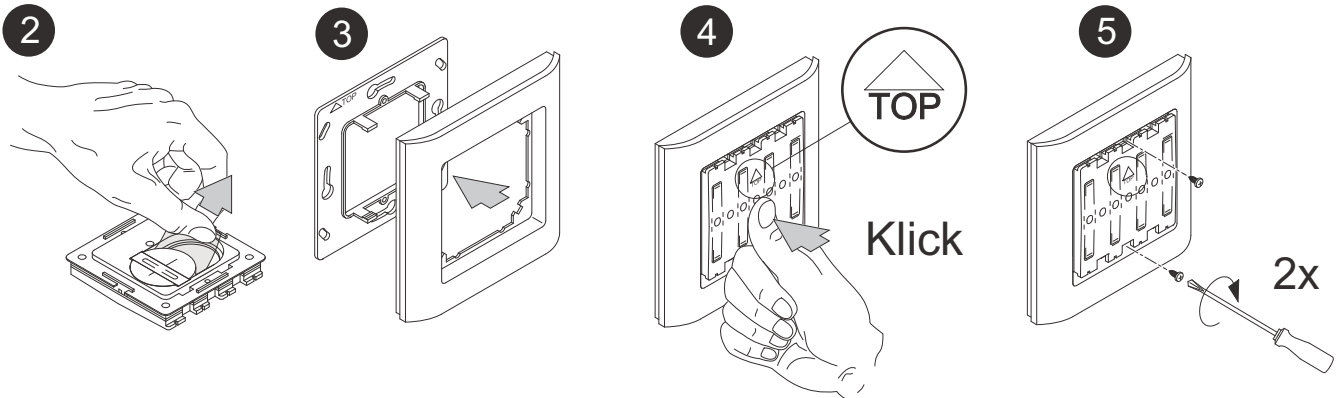
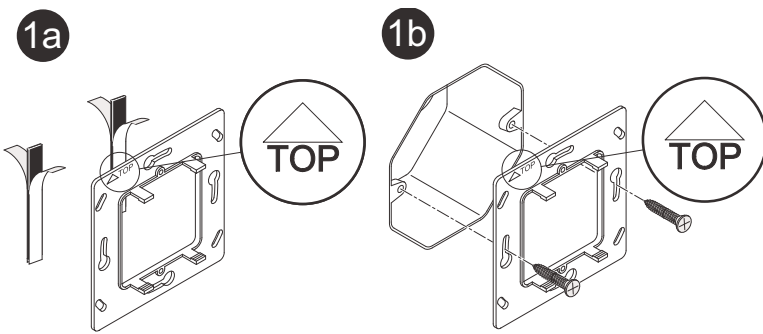
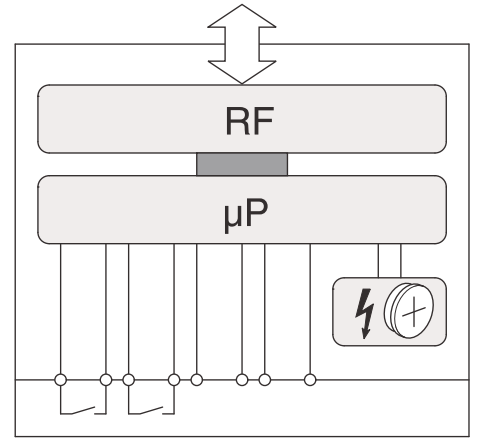
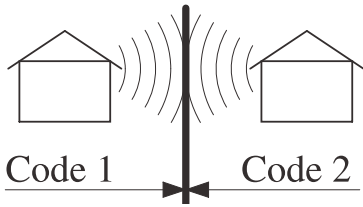
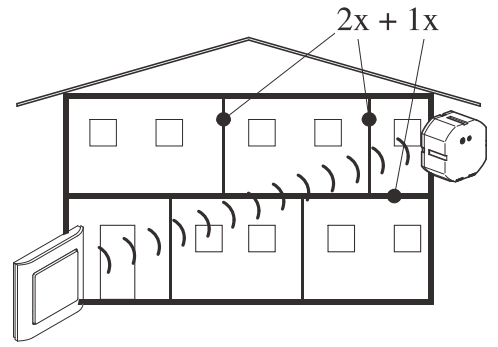
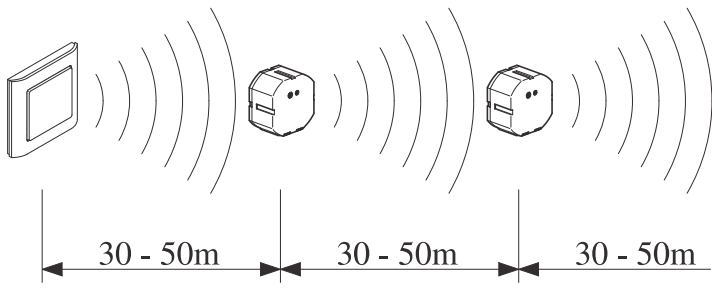

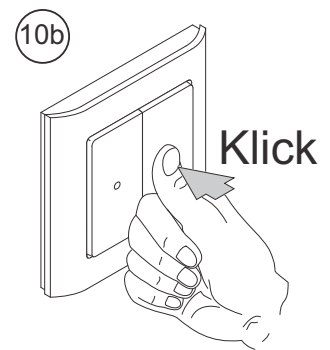
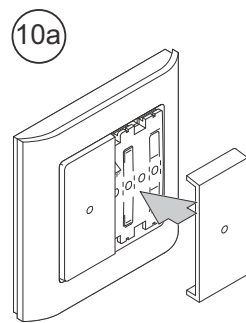
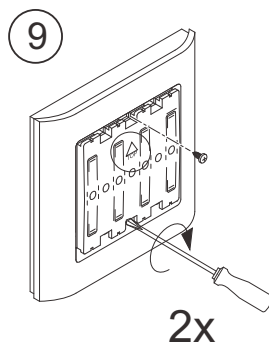
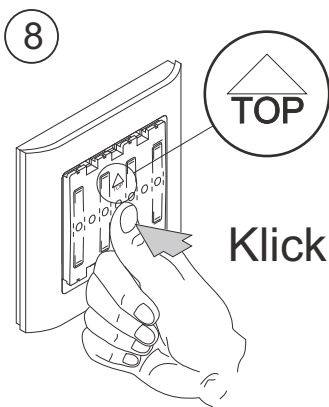
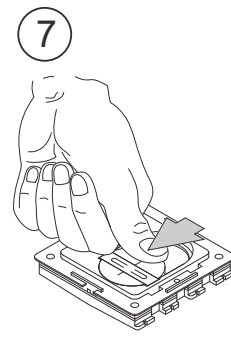
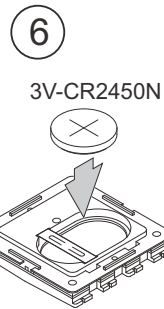
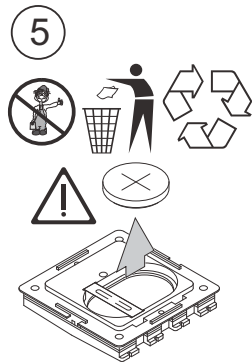
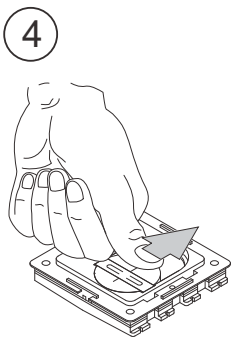
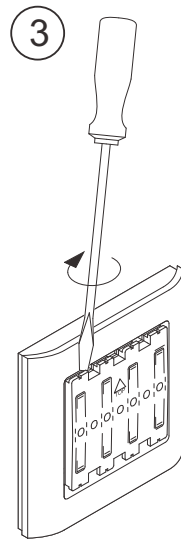
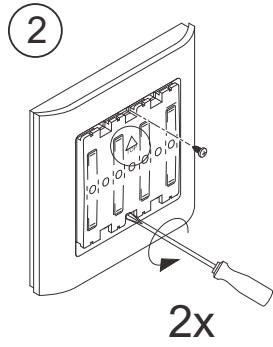
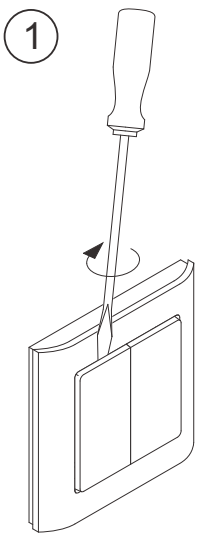

**CTAA-0X/04-LED**

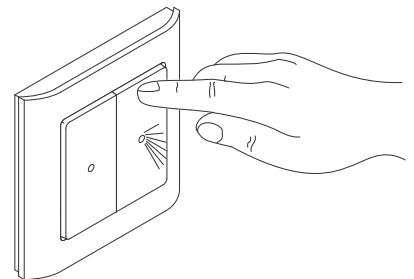
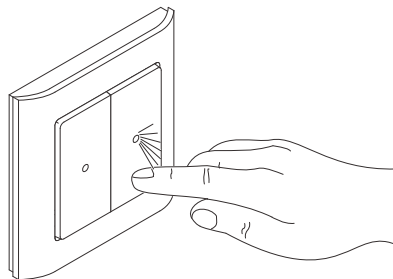

ca. 60-90%	ca. 80-95%	ca. 20-60%	ca. 0-10%	ca. 70-90%	



# Declaration of Conformity

We, EATON Industries (Austria) GmbH  
3943 Schrems, Eugenia 1  
Austria

declare that product (family)

## Eaton - Push Button,

### CTAA-...

(the declaration of conformity applies to all listed types within our actual product catalog)

provided that it is installed, maintained and used in the application intended for, with respect to the relevant manufacturers instructions, installation standards and "good engineering practices"

complies with the provisions of Council directive(s):

EMC Directive 2004/108/EC

Radio and Telecommunications Terminal Equipment 99/05/EC

RoHS Directive 2011/65/EU

based on compliance with European standard(s):

EN301489-3 V1.6.1, EN300220-2 V2.4.1, EN50491-5-1/10, EN50491-5-2/10, EN60950-1/06 + A11/09 + A1/10 + A12/11 + A2/13, EN62479/10



01.12.2014

tested by:  
TÜV Austria Services GmbH, Notified Body **CE 0408**  
1230 Vienna, Deutschstrasse 10, Austria

Heinz Ursprunger  
Director Product Line  
& Marketing Management

Friedrich Schröder  
Director Quality  
& EHS

Affixing date of CE mark: 2003

Doc.Id.: CTAA-...

## RF- SYSTEM

### BASIC - MODE - CARD

<p>CTAA-01/01</p> <p>CTAA-02/01</p> <p>CBEU-02/01</p> <p>CBEU-02/02</p> <p>M1 M2 M3 M4</p> <p>1x 2x 3x 4x</p> <p>CRCA-00/01</p> <p>CHSZ-00/01</p>	<p>CSAU-01/01</p> <p>CJAU-01/01</p> <p>CDAU-01/01</p>	
---	---	--