



Produkt beskrivelse

Familie av en-soklede, kompakte, høyeffektive utladningslamper med stabil farge gjennom hele levetiden med krisp, utstrålende lys

Produktfordeler

- Stabilt fargetemperatur gjennom hele levetiden
- Høy lampe-effektivitet resulterer i lave driftskostnader
- Lang levetid sammenlignet med gløde- og halogenlamper
- Relativt liten varme-avgivelse øker komforten for kunder og betjening
- Alle typer har UV-blokkering for å redusere risikoen for bleking

Produktegenskaper

- Krisp hvitt lys
- Suveren fargegjengivelse
- Gjør mulig kompakt, liten, armaturdesign som gir høy stråleintensitet

Miljø

- Godt miljøvalg på grunn av høy energieffektivitet og lang pålitelig levetid.
- Dette produktet innfrir kravene i RoHS direktivet.
- Dette produktet omfattes av WEEE / Renas ordningen.

Bruksområder

- Butikker og butikkvinduer, kontorer og offentlige bygninger
- Dekorativt utendørs: flombelysning og gågater

Sikkerhet og forholdsregler

- Bruk bare i totalt innelukkede armaturer, selv under testing (IEC 61167, IEC 62035, IEC 60598)
- Armaturen må kunne inneholde varme lyskilder hvis lampen sprekker
- Kontrollutstyr må omfatte avhendingsbeskyttelse (IEC 61167, IEC 62035)
- Lamper kan brukes med elektronisk eller elektromagnetisk kontrollutstyr, bortsett fra lampene 35 W / 942 og 20 W, som må brukes med elektronisk kontrollutstyr.
- Det er svært lite sannsynlig at en lampe som går i stykker, vil påvirke helsen din. Hvis en lampe går i stykker, lufter du rommet i 30 minutter og fjerner delene, helst med hansker. Legg dem i en egen plastpose, og lever dem til et mottak for resirkulering. Ikke bruk støvsuger.

Dimensjons tegninger

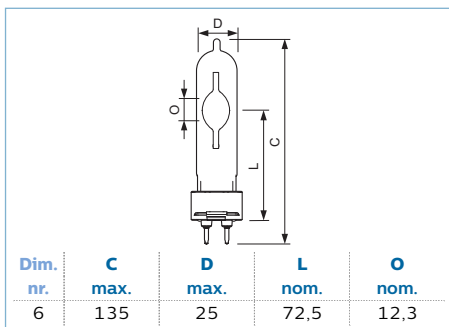
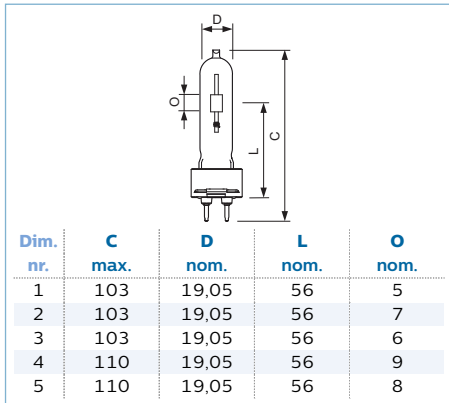

Produktbilder



Main Data

MASTERColour CDM-T

Effekt/Lyskildefarge	Lyskildefeste	SAP Packing (Piece)/Innpakningstype	Driftsposisjon		Dim. nr.	Bilde brev	EOC 8711500...
39W/830	G12	CT / 1	UNIVERSAL	A	1	A	19697215
39W/842	G12	CT / 1	UNIVERSAL	A	1	A	21126215
73W/830	G12	CT / 1	UNIVERSAL	A+	2	B	19699615
73W/942	G12	CT / 1	UNIVERSAL	A+	3	B	19927015

Mer data se neste side

MASTERColour CDM-T

Effekt/Lyskildefarge	Lyskildefeste	SAP Packing (Piece)/Innpakningstype	Driftsposisjon		Dim. nr.	Bilde brev	EOC 8711500...
147W/830	G12	CT / 1	UNIVERSAL	A+	4	C	19780115
147W/942	G12	CT / 1	UNIVERSAL	A	5	C	20005115
247W/942	G12	CT / 1	UNIVERSAL	A+	6	D	21112515
249W/830	G12	CT / 1	UNIVERSAL	A+	6	D	20801915

Elektriske data

Kommersielt produktnavn	Lampe strøm EL (A)	lyskildestrøm (EM) (A)	Lyskildestrøm (W)	Spenning (V)	Tenningtid (sec. [max.])
MASTERColour CDM-T 35W/830 G12 1CT/12	0,47	0,53	39	88	30
MASTERColour CDM-T 35W/842 G12 1CT/12	0,46		39	85	30
MASTERColour CDM-T 70W/830 G12 1CT/12	0,87	0,98	73	88	30
MASTERColour CDM-T 70W/942 G12 1CT/12	0,87	0,98	73	88	30
MASTERColour CDM-T 150W/830 G12 1CT	1,60	1,80	147	96	30
MASTERColour CDM-T 150W/942 G12 1CT	1,70	1,90	147	90	30
MASTERColour CDM-T 250W/830 G12 1CT/12		2,99	249	95	30
MASTERColour CDM-T 250W/942 G12 1CT/12		3,04	247	93	30

Lifetime data

Kommersielt produktnavn	Levetid til 5 % lystap (h)	Levetid til 10 % lystap (h)	Levetid til 20 % lystap (h)	Levetid til 50 % lystap (h)
MASTERColour CDM-T 35W/830 G12 1CT/12	9 000	10 000	11 000	12 000
MASTERColour CDM-T 35W/842 G12 1CT/12	9 000	10 000	11 000	12 000
MASTERColour CDM-T 70W/830 G12 1CT/12	9 000	10 000	11 000	12 000
MASTERColour CDM-T 70W/942 G12 1CT/12	9 000	10 000	11 000	12 000
MASTERColour CDM-T 150W/830 G12 1CT	9 000	10 000	11 000	12 000
MASTERColour CDM-T 150W/942 G12 1CT	9 000	10 000	11 000	12 000
MASTERColour CDM-T 250W/830 G12 1CT/12	3 500	10 000	12 000	15 000
MASTERColour CDM-T 250W/942 G12 1CT/12	3 500	10 000	12 000	15 000

Color data

Kommersielt produktnavn	Fargegjengivelse (maks.)	Lyskildefarge ¹	Fargebetegnelse	Lyspæreover- flate	Fargepunkt X	Fargepunkt Y
MASTERColour CDM-T 35W/830 G12 1CT/12	81	830	Varm hvit (WW)	Klar (CL)	0,428	0,397
MASTERColour CDM-T 35W/842 G12 1CT/12	84	842	Kaldhvit (CW)	Klar (CL)	0,370	0,367
MASTERColour CDM-T 70W/830 G12 1CT/12	84	830	Varm hvit (WW)	Klar (CL)	0,432	0,395
MASTERColour CDM-T 70W/942 G12 1CT/12	92	942	Kaldhvit (CW)	Klar (CL)	0,377	0,376
MASTERColour CDM-T 150W/830 G12 1CT	88	830	Varm hvit (WW)	Klar (CL)	0,436	0,396
MASTERColour CDM-T 150W/942 G12 1CT	96	942	Kaldhvit (CW)	Klar (CL)	0,375	0,363
MASTERColour CDM-T 250W/830 G12 1CT/12	85	830	Varm hvit (WW)	Klar (CL)	0,435	0,393
MASTERColour CDM-T 250W/942 G12 1CT/12	>91	942	Kaldhvit (CW)	Klar (CL)	0,376	0,368

¹ 'Lyskildefarge' verdi beskrivelse (er): '830' = CCT av 3 000 K, '842' = CCT av 4 200 K, '942' = CCT av 4 200 K

Luminous flux/efficacy/intensity data

Kommersielt produktnavn	Lysstrøm (merkekapasitet) (nominell) (lm)	Lyseffekt (merkekapasitet) (maks.) (lm/W)	Ratio Scotopic/Photopic Lumens
MASTERColour CDM-T 35W/830 G12 1CT/12	3 120	80,0	
MASTERColour CDM-T 35W/842 G12 1CT/12	3 000	77,0	
MASTERColour CDM-T 70W/830 G12 1CT/12	6 400	88,0	
MASTERColour CDM-T 70W/942 G12 1CT/12	6 300	86,0	
MASTERColour CDM-T 150W/830 G12 1CT	13 300	90,0	
MASTERColour CDM-T 150W/942 G12 1CT	12 400	84,0	
MASTERColour CDM-T 250W/830 G12 1CT/12	27 540	111,0	1,30
MASTERColour CDM-T 250W/942 G12 1CT/12	26 000	105,0	1,75

21



Rated Lumen Maintenance data

Kommersielt produktnavn	Lumenedlikehold 2000 t	Lumenedlikehold 5000 t	Lumenedlikehold 10 000 t
	(%)	(%)	(%)
MASTERColour CDM-T 35W/830 G12 1CT/12	80	70	50
MASTERColour CDM-T 35W/842 G12 1CT/12	90	85	70
MASTERColour CDM-T 70W/830 G12 1CT/12	85	80	70
MASTERColour CDM-T 70W/942 G12 1CT/12	85	75	65
MASTERColour CDM-T 150W/830 G12 1CT	75	70	60
MASTERColour CDM-T 150W/942 G12 1CT	85	80	70
MASTERColour CDM-T 250W/830 G12 1CT/12	98	97	92
MASTERColour CDM-T 250W/942 G12 1CT/12	98	94	86

Temperature data

Kommersielt produktnavn	Korrelert fargetemperatur	Color Temperature Technical	Lyspæretemperatur	Temperatur lyskildefeste	Default Ambient Temperature
	(K)	(K)	(°C [max.])	(°C [max.])	(°C)
MASTERColour CDM-T 35W/830 G12 1CT/12	3 000	3 095	500	280	25
MASTERColour CDM-T 35W/842 G12 1CT/12	4 200	4 200	500	280	25
MASTERColour CDM-T 70W/830 G12 1CT/12	3 000	2 900	500	280	25
MASTERColour CDM-T 70W/942 G12 1CT/12	4 200	3 900	500	280	25
MASTERColour CDM-T 150W/830 G12 1CT	3 000	2 950	650	280	25
MASTERColour CDM-T 150W/942 G12 1CT	4 200	4 050	650	280	25
MASTERColour CDM-T 250W/830 G12 1CT/12	3 000	2 940	700	280	25
MASTERColour CDM-T 250W/942 G12 1CT/12	4 200	4 070	700	280	25

Environmental data & ETIM group & Design Requirements

Kommersielt produktnavn	Energiforbruk kWh/1000 t		Lavt kvikksølv (Hg) - innhold	ETIM Group ²
	(kWh)		(mg)	
MASTERColour CDM-T 35W/830 G12 1CT/12	43	A	3,10	EC000037
MASTERColour CDM-T 35W/842 G12 1CT/12	43	A	2,70	EC000037
MASTERColour CDM-T 70W/830 G12 1CT/12	80	A+	4,50	EC000037
MASTERColour CDM-T 70W/942 G12 1CT/12	80	A+	6,10	EC000037
MASTERColour CDM-T 150W/830 G12 1CT	162	A+	14,25	EC000037
MASTERColour CDM-T 150W/942 G12 1CT	162	A	10,40	EC000037
MASTERColour CDM-T 250W/830 G12 1CT/12	274	A+	27,00	EC000037
MASTERColour CDM-T 250W/942 G12 1CT/12	272	A+	19,00	EC000037

² 'ETIM Group' verdi beskrivelse (er): 'EC000037' = Metallhalogen lampe uten reflektor

System data

Kommersielt produktnavn	Opprinnelig inngangseffekt (W)
MASTERColour CDM-T 35W/830 G12 1CT/12	44
MASTERColour CDM-T 35W/842 G12 1CT/12	44
MASTERColour CDM-T 70W/830 G12 1CT/12	83
MASTERColour CDM-T 70W/942 G12 1CT/12	80
MASTERColour CDM-T 150W/830 G12 1CT	167
MASTERColour CDM-T 150W/942 G12 1CT	167
MASTERColour CDM-T 250W/830 G12 1CT/12	271
MASTERColour CDM-T 250W/942 G12 1CT/12	271

Driftsdata

Kommersielt produktnavn	Driftsposisjon ³	Default Burning Position	Forsynings-spennning, tenning (V [min.])	Forsynings-spennning, tenning (V [max.])	Default Gear	Kan dimmes	Default Cycle Time
MASTERColour CDM-T 35W/830 G12 1CT/12	UNIVERSAL	Vertical	198	198	Electronic	Nei	12 hour cycle
MASTERColour CDM-T 35W/842 G12 1CT/12	UNIVERSAL	Vertical	198	198	Electronic	Nei	12 hour cycle
MASTERColour CDM-T 70W/830 G12 1CT/12	UNIVERSAL	Vertical	198	198	Electronic	Nei	12 hour cycle

Mer data se neste side



Kommersielt produktnavn	Driftsposisjon ³	Default Burning Position	Forsynings-spennning, tenning (V [min.])	Forsynings-spennning, tenning (V [max.])	Default Gear	Kan dimmes	Default Cycle Time
MASTERColour CDM-T 70W/942 G12 1CT/12	UNIVERSAL	Vertical	198	198	Electronic	Nei	12 hour cycle
MASTERColour CDM-T 150W/830 G12 1CT	UNIVERSAL	Vertical	198	198	Electronic	Nei	12 hour cycle
MASTERColour CDM-T 150W/942 G12 1CT	UNIVERSAL	Vertical	198	198	Electronic	Nei	12 hour cycle
MASTERColour CDM-T 250W/830 G12 1CT/12	UNIVERSAL	Vertical	198	198	Electromagnetic	Nei	12 hour cycle
MASTERColour CDM-T 250W/942 G12 1CT/12	UNIVERSAL	Vertical	198	198	Electromagnetic	Nei	12 hour cycle

³ 'Driftsposisjon' verdi beskrivelse (er): 'UNIVERSAL' = Universell

UV related data

Kommersielt produktnavn	Skadefaktor	Pet (Niosh) (h/500lx [min.])
MASTERColour CDM-T 35W/830 G12 1CT/12		8
MASTERColour CDM-T 35W/842 G12 1CT/12		8
MASTERColour CDM-T 70W/830 G12 1CT/12		8
MASTERColour CDM-T 70W/942 G12 1CT/12		8
MASTERColour CDM-T 150W/830 G12 1CT		8
MASTERColour CDM-T 150W/942 G12 1CT		8
MASTERColour CDM-T 250W/830 G12 1CT/12	0,15	8
MASTERColour CDM-T 250W/942 G12 1CT/12	0,28	8

Miscellaneous & General data

Kommersielt produktnavn	Lyspæreform ⁴	Lyskildedefeste	ANSI-kode	ILCOS Code
MASTERColour CDM-T 35W/830 G12 1CT/12	T19	G12	C130/E	MT/UB-35/830-H-G12-20/90
MASTERColour CDM-T 35W/842 G12 1CT/12	T19	G12		MT/UB-35/842-H-G12-20/90
MASTERColour CDM-T 70W/830 G12 1CT/12	T19	G12	C139/E	MT/UB-70/830-H-G12-20/90
MASTERColour CDM-T 70W/942 G12 1CT/12	T19	G12	C139/E	MT/UB-70/942-H-G12-20/90
MASTERColour CDM-T 150W/830 G12 1CT	T19	G12	C142/E	MT/UB-150/830-H-G12-21/100
MASTERColour CDM-T 150W/942 G12 1CT	T19	G12	C142/E	MT/UB-150/942-H-G12-21/100
MASTERColour CDM-T 250W/830 G12 1CT/12	T24	G12		MT/UB-250/830-H-G12-25/135
MASTERColour CDM-T 250W/942 G12 1CT/12	T24	G12		MT/UB-250/942-H-G12-25/135

⁴ 'Lyspæreform' verdi beskrivelse (er): 'T19' = T 19mm, 'T24' = T 24mm

Lagerdata

Kommersielt produktnavn	SAP Packing (Piece)/Innpakningstype	Teller - stykker per utvendige boks	SAP Local code	EOC 8711500...	Materialenr. (12NC) (9280...)	SAP Gross Weight (Piece) (g)	Nettovekt (stykk) (g)	Strekkode EAN 8711500...
MASTERColour CDM-T 35W/830 G12 1CT/12	CT / 1	12	38 582 40	19697215	83105125	39	27	196989
MASTERColour CDM-T 35W/842 G12 1CT/12	CT / 1	12	38 582 12	21126215	94305125	40	28	211279
MASTERColour CDM-T 70W/830 G12 1CT/12	CT / 1	12	38 582 41	19699615	82305125	41	29	197009
MASTERColour CDM-T 70W/942 G12 1CT/12	CT / 1	12	38 582 51	19927015	84505131	42	29	199287
MASTERColour CDM-T 150W/830 G12 1CT	CT / 1	12	38 582 42	19780115	83705125	45	33	197818
MASTERColour CDM-T 150W/942 G12 1CT	CT / 1	12	38 582 52	20005115	84605131	47	33	200068
MASTERColour CDM-T 250W/830 G12 1CT/12	CT / 1	12	38 582 11	20801915	89805131	60	39	208026
MASTERColour CDM-T 250W/942 G12 1CT/12	CT / 1	12	38 582 14	21112515	94205131	60	39	211132

⁵ 'SAP Packing (Piece)/Innpakningstype' verdi beskrivelse (er): 'CT / 1' = CARTON

Energifordeling

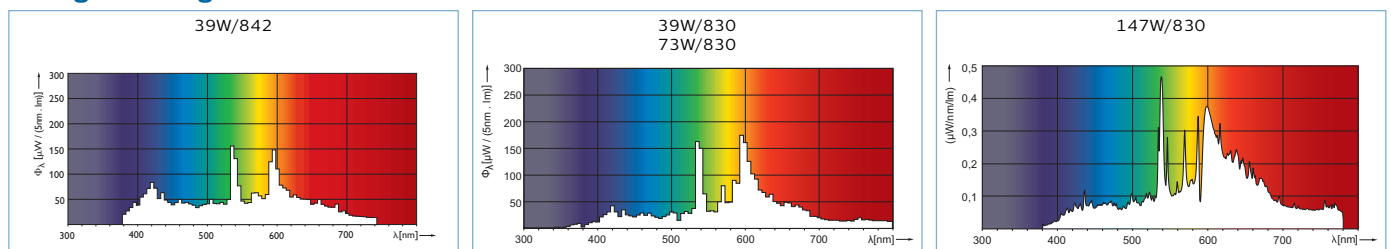

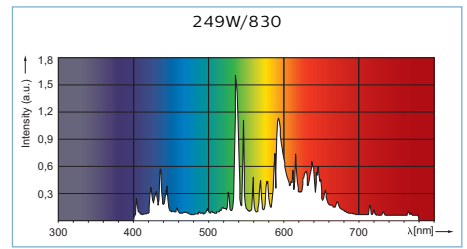
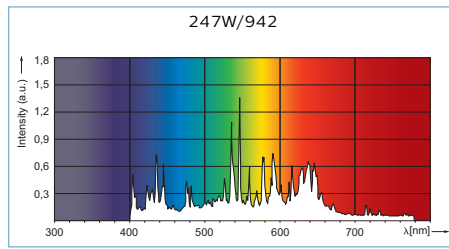
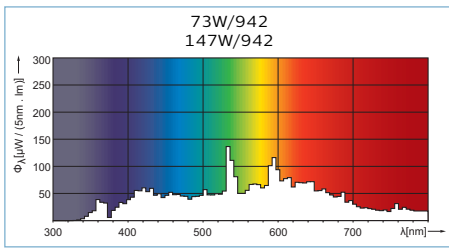

Ytelses diagrammer

1360-13678

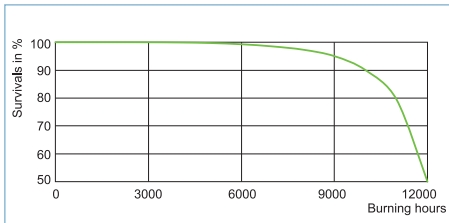

13678

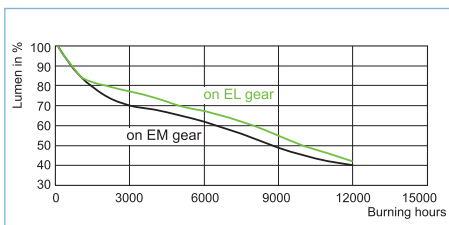

15017

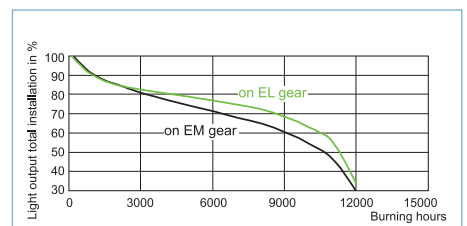
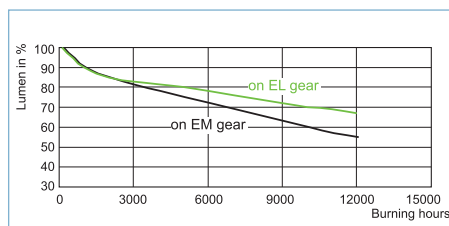
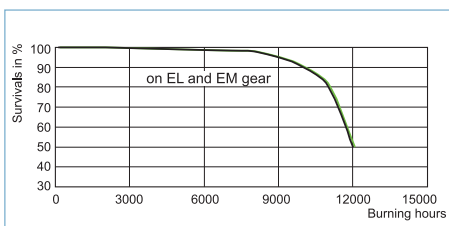

15034

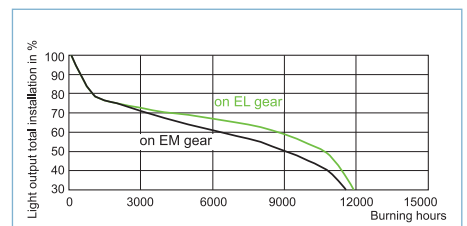
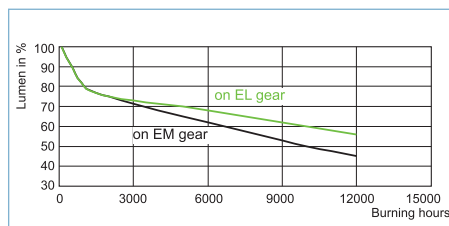
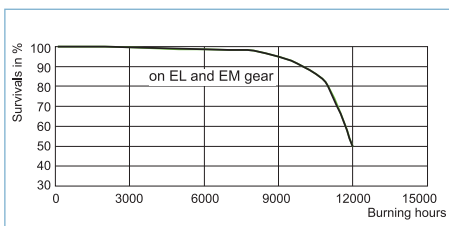

15065

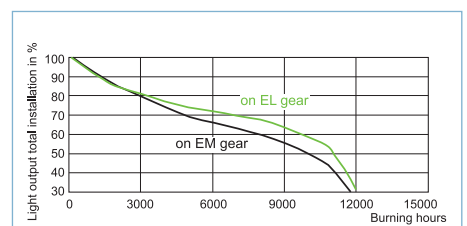
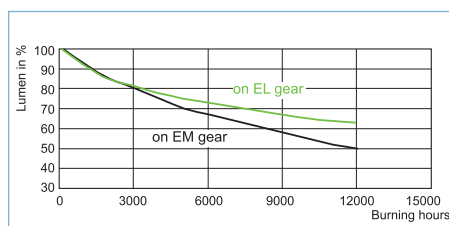
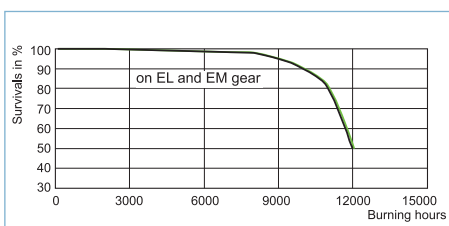

15076

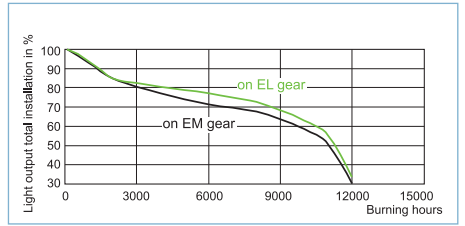
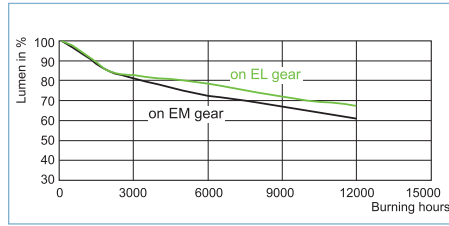
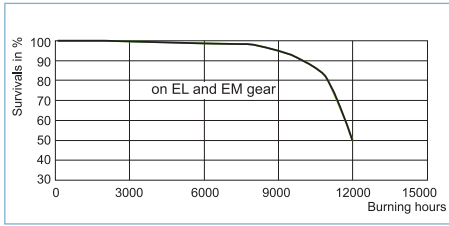

CDM-T 250W

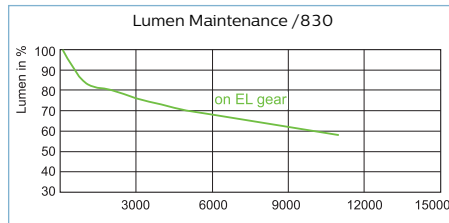
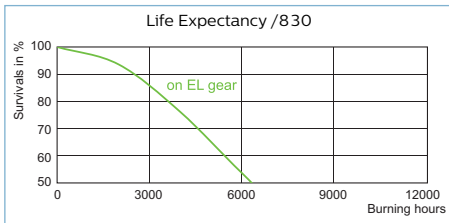

Cap-Base Overview

