

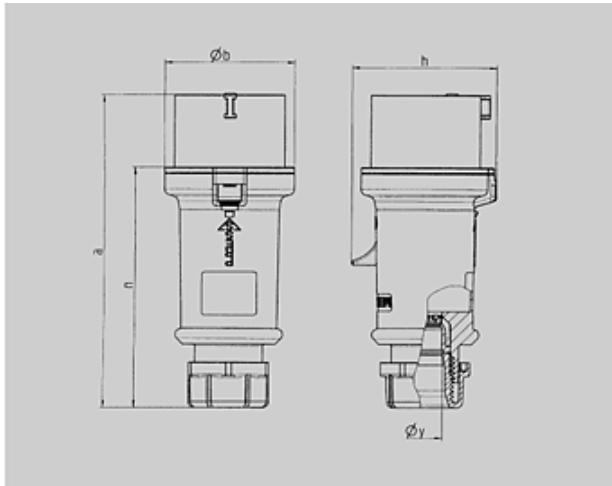

Part no. : 163

Plug ProTOP

with cable gland with integral protection against kinking. Front and cover fitted with thread lock and safety slide.



Drawing	Amp. Poles	16			32		
		3	4	5	3	4	5
2 MB 214	Dim. in mm						
	a	148	160	160	197	197	197
	b	55	65,6	65,6	75	75	75
	h	61	72,5	72,5	80,5	80,5	85
	n	112	123,5	123,5	152	152	152
	y	14,5	16	16	22	22	22
	Terminal for cond. cross section (mm ²) min.-max.	1	1	1	2,5	2,5	2,5
		-2,5	-2,5	-2,5	-6	-6	-6

 Article-group : **2197**

voltages : 230V

rated current : 32A

pole : 4 pole







IP protection types : IP44

position of ground contact : 9h

packing unit : 0010

weight : 270 g

PART NUMBERS

	V	110V	230V	400V	500V	>50-500V	
		50,60	50,60	50,60	50,60	100-300	300-500
	Hz						
	colour						
	amp.						
16 A	3	147A	148A	149A		647	
	4	654	151A	152A	153A	657	658
	5		157A	13A	659	757	769
32 A	3	159	160				
	4		<u>163</u>	164	165	773	
	5		169A	14A	777		