

## Datablad | Artikkelnummer: 2773-405

KOMPAKT skjøtekontakt; for massive og tvinnede ledere; maks. 4 mm<sup>2</sup>; 5-  
leder; gjennomsiktig hylse; gult deksel; Omgivelsestemperatur: maks. 85 °C  
(T85); 4,00 mm<sup>2</sup>; gjennomsiktig

[www.wago.com/2773-405](http://www.wago.com/2773-405)

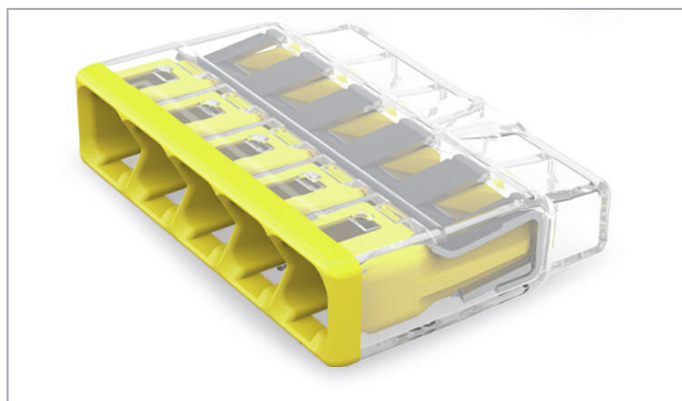
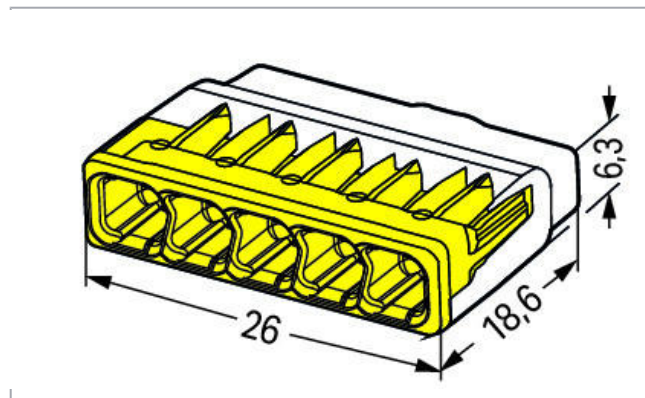

### Element beskrivelse

Advantages:

- Convenient wiring via extremely compact design
- Push-in termination of up to eight solid and stranded conductors
- Conductor range: 0.75 ... 4 mm<sup>2</sup> "s" and 1.5 ... 4 mm<sup>2</sup> "st"
- Any combination of conductor sizes is possible
- PUSH WIRE® connection terminates solid ("s") copper conductors

Med forbehold om endringer. Vær også oppmerksom på ytterligere produktdokumentasjon!

WAGO Norge AS  
Jerikoveien 20  
1067 Oslo  
Tel.: +47 22 30 94 60 | Fax: +47 22 30 94 51  
Email: [info.no@wago.com](mailto:info.no@wago.com)

Har du spørsmål om våre produkter?  
Vi tar alltid gjerne imot di samtale på +49 (571) 887-44222.

## Data

### Electrical data

#### Ratings per IEC/EN 60664-1

Ratings per	IEC/EN 60664-1
Rated voltage (II / 2)	450 V
Rated impulse voltage (II / 2)	4 kV
Rated current	32 A
Legend (ratings)	(II / 2) $\triangleq$ Overvoltage category II / Pollution degree 2

#### Approvals per UL 1059

Approvals per	UL 486C
Rated voltage UL (Use Group C)	600 V
Rated current UL (Use Group C)	20 A

### Connection data

Connection technology	PUSH WIRE <sup>®</sup>
Actuation type	Push-in
Connectable conductor materials	Copper
Solid conductor	0,75 ... 4 mm <sup>2</sup> / 20 ... 12 AWG
Stranded conductor	1,5 ... 4 mm <sup>2</sup> / 18 ... 12 AWG
Conductor diameter	2 ... 1,6 mm
Strip length	13 mm / 0.51 inch
Total number of connection points	5
Total number of potentials	1
Type of wiring	Side-entry wiring

### Geometrical Data

Width	26 mm / 1.024 inch
Height	6,3 mm / 0.248 inch
Depth	18,6 mm / 0.732 inch

### Material Data

Color	gjennomsiktig
Cover color	yellow
Flammability class per UL94	V2

Med forbehold om endringer. Vær også oppmerksom på ytterligere produktdokumentasjon!

Weight	2,6 g
--------	-------

### Environmental Requirements

Surrounding air (operating) temperature	85 °C
Continuous operating temperature	105 °C
T-Marking per EN 60998	T85

### Commercial data

Packaging type	BOX
Country of origin	DE
GTIN	4055143919241
Customs tariff number	85369010000

### Godkjenninger / sertifikater

#### Landspesifikke godkjenninger

Logo	Godkjenning	Ytterligere godkjenningstekst	Sertifikatnavn
	<b>CB</b> DEKRA Certification B.V.	IEC 60998	NL-49187
	<b>KEMA/KEUR</b> DEKRA Certification B.V.	EN 60669	71-101844

#### UL-godkjenninger

Logo	Godkjenning	Ytterligere godkjenningstekst	Sertifikatnavn
	<b>UL</b> Underwriters Laboratories Inc.	UL 467	20180215- E201573

### Kompatible produkter

#### Mounting adapter

	<b>Elementnr.: 2773-500</b> Montasjebærer; for forbindelser med enkel/dobbel tilkob; 2773-Serien; for DIN-35 skinne- / skrue montering; oransje	<a href="http://www.wago.com/2773-500">www.wago.com/2773-500</a>
--	--	--

Med forbehold om endringer. Vær også oppmerksom på ytterligere produktdokumentasjon!

WAGO Norge AS  
Jerikoveien 20  
1067 Oslo  
Tel.: +47 22 30 94 60 | Fax: +47 22 30 94 51  
Email: [info.no@wago.com](mailto:info.no@wago.com)

Har du spørsmål om våre produkter?  
Vi tar alltid gjerne imot di samtale på +49 (571) 887-44222.

## Nedlastinger Documentation

Additional Information  
Technical explanations

Apr 3, 2019

pdf  
2,2 MB

Last ned

## Installasjonsmerknader

### Conductor termination

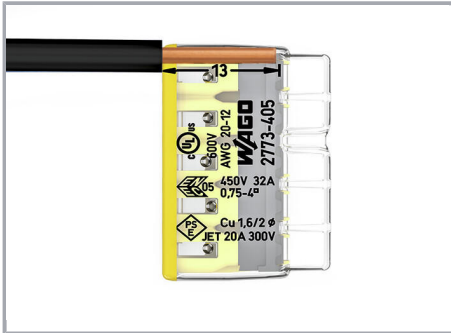

Strip solid or stranded conductor to 13 mm (0.51 inch)..

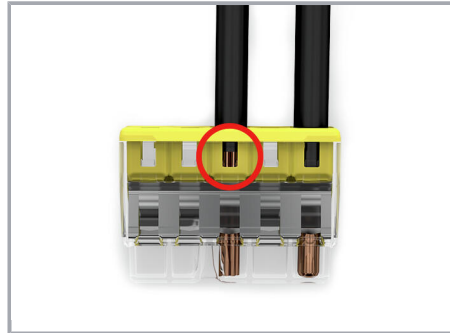

The transparent housing shows if conductors are fully inserted; within the colored base, a clear port shows if the conductor's strip length is correct. Conductors are correctly stripped if the clear port shows no bare conductor on the unprinted connector side. Picture shows center conductor with exceeded strip length.

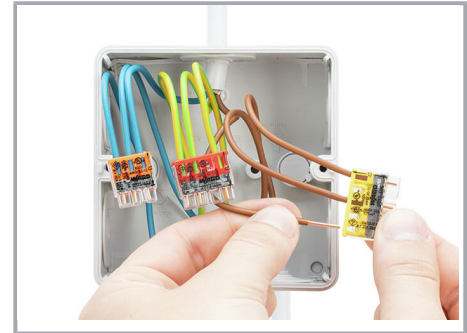

Termination: Insert the stripped conductor until it hits the backstop.

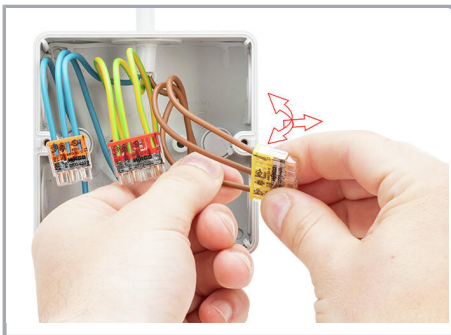

Removal: Hold solid conductor to be removed and twist alternately left and right while pulling the connector.

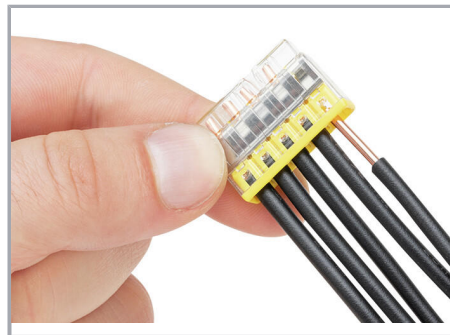

Solid conductors are inserted into the connector by simply pushing them in.

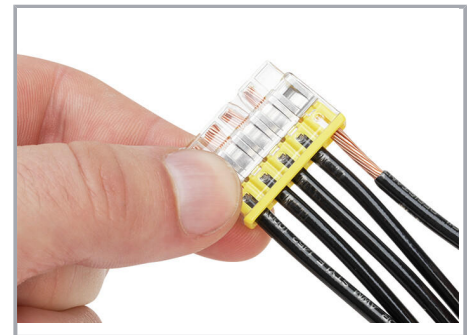

Stranded conductors are inserted into the connector by simply pushing them in.

## Testing

Med forbehold om endringer. Vær også oppmerksom på ytterligere produktdokumentasjon!

WAGO Norge AS  
Jerikoveien 20  
1067 Oslo  
Tel.: +47 22 30 94 60 | Fax: +47 22 30 94 51  
Email: [info.no@wago.com](mailto:info.no@wago.com)

Har du spørsmål om våre produkter?  
Vi tar alltid gjerne imot di samtale på +49 (571) 887-44222.



Testing via test port opposite to conductor entry.

#### Application

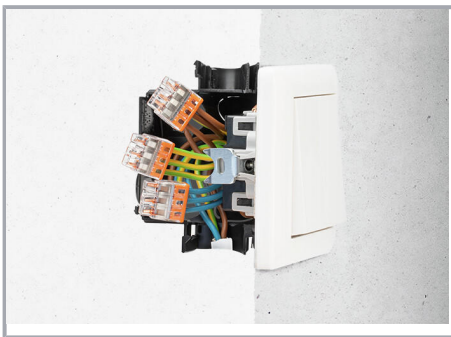

Thanks to their flat and compact design, these connectors are ideal for wiring in flush-mount switch boxes.

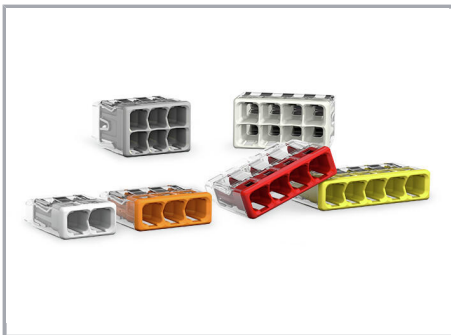

With six variants, always have the right connector.

Med forbehold om endringer. Vær også oppmerksom på ytterligere produktdokumentasjon!

WAGO Norge AS  
Jerikoveien 20  
1067 Oslo  
Tel.: +47 22 30 94 60 | Fax: +47 22 30 94 51  
Email: [info.no@wago.com](mailto:info.no@wago.com)

Har du spørsmål om våre produkter?  
Vi tar alltid gjerne imot di samtale på +49 (571) 887-44222.