

Datablad | Artikkelnummer: 2773-403

KOMPAKT skjøtekontakt; for massive og tvinnede ledere; maks. 4 mm²; 3-
leder; gjennomsiktig hylse; oransje deksel; Omgivelsestemperatur: maks. 85 °
C (T85); 4,00 mm²; gjennomsiktig

www.wago.com/2773-403

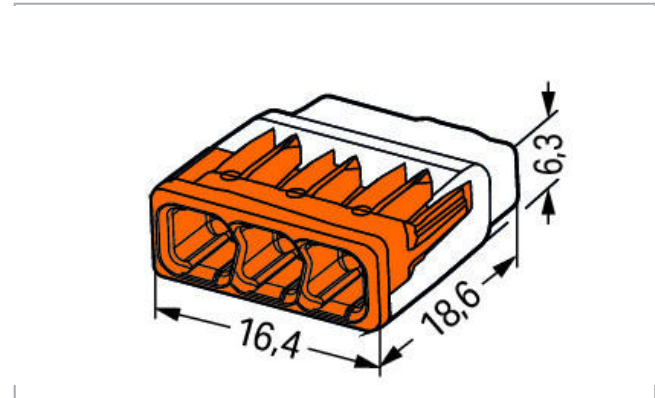

RoHS  Compliant 

Element beskrivelse

Advantages:

- Convenient wiring via extremely compact design
- Push-in termination of up to eight solid and stranded conductors
- Conductor range: 0.75 ... 4 mm² "s" and 1.5 ... 4 mm² "st"
- Any combination of conductor sizes is possible
- PUSH WIRE® connection terminates solid ("s") copper conductors

Data

Electrical data

Ratings per IEC/EN 60664-1

Ratings per	IEC/EN 60664-1
Rated voltage (II / 2)	450 V
Rated impulse voltage (II / 2)	4 kV
Rated current	32 A
Legend (ratings)	(II / 2) ≙ Overvoltage category II / Pollution degree 2

Med forbehold om endringer. Vær også oppmerksom på ytterligere produktdokumentasjon!

WAGO Norge AS
Jerikoveien 20
1067 Oslo
Tel.: +47 22 30 94 60 | Fax: +47 22 30 94 51
Email: info.no@wago.com

Har du spørsmål om våre produkter?
Vi tar alltid gjerne imot di samtale på +49 (571) 887-44222.



Approvals per UL 1059

Approvals per	UL 486C
Rated voltage UL (Use Group C)	600 V
Rated current UL (Use Group C)	20 A

Connection data

Connection technology	PUSH WIRE®
Actuation type	Push-in
Connectable conductor materials	Copper
Solid conductor	0,75 ... 4 mm ² / 20 ... 12 AWG
Stranded conductor	1,5 ... 4 mm ² / 18 ... 12 AWG
Conductor diameter	2 ... 1,6 mm
Strip length	13 mm / 0.51 inch
Total number of connection points	3
Total number of potentials	1
Type of wiring	Side-entry wiring

Geometrical Data

Width	16,4 mm / 0.646 inch
Height	6,3 mm / 0.248 inch
Depth	18,6 mm / 0.732 inch

Material Data

Color	gjennomsiktig
Cover color	orange
Flammability class per UL94	V2
Weight	1,6 g

Environmental Requirements

Surrounding air (operating) temperature	85 °C
Continuous operating temperature	105 °C
T-Marking per EN 60998	T85

Commercial data

Packaging type	BOX
----------------	-----

Med forbehold om endringer. Vær også oppmerksom på ytterligere produktdokumentasjon!

WAGO Norge AS
Jerikoveien 20
1067 Oslo
Tel.: +47 22 30 94 60 | Fax: +47 22 30 94 51
Email: info.no@wago.com

Har du spørsmål om våre produkter?
Vi tar alltid gjerne imot di samtale på +49 (571) 887-44222.

Country of origin	DE
GTIN	4055143927550
Customs tariff number	85369010000

Godkjenninger / sertifikater

Landspesifikke godkjenninger

Logo	Godkjenning	Ytterligere godkjenningstekst	Sertifikatnavn
	CB DEKRA Certification B.V.	IEC 60998	NL-49187
	KEMA/KEUR DEKRA Certification B.V.	EN 60669	71-101844

UL-godkjenninger

Logo	Godkjenning	Ytterligere godkjenningstekst	Sertifikatnavn
	UL Underwriters Laboratories Inc.	UL 467	20180215- E201573

Kompatible produkter

Mounting adapter

	Elementnr.: 2773-500 Montasjebærer; for forbindelser med enkel/dobbel tilkob; 2773-Serien; for DIN-35 skinne- / skrue montering; oransje	www.wago.com/2773-500
--	--	--

Nedlastinger

Documentation

Additional Information

Technical explanations	Apr 3, 2019	pdf 2,2 MB	Last ned
------------------------	-------------	---------------	----------

Installasjonsmerknader

Conductor termination

Med forbehold om endringer. Vær også oppmerksom på ytterligere produktdokumentasjon!

WAGO Norge AS
Jerikoveien 20
1067 Oslo
Tel.: +47 22 30 94 60 | Fax: +47 22 30 94 51
Email: info.no@wago.com

Har du spørsmål om våre produkter?
Vi tar alltid gjerne imot di samtale på +49 (571) 887-44222.

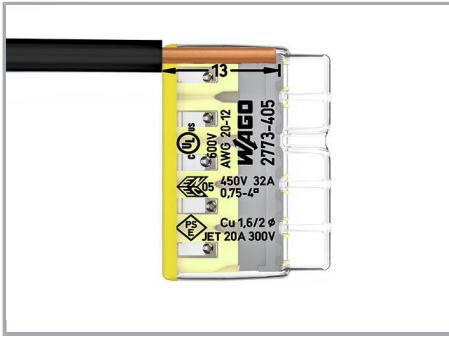

Strip solid or stranded conductor to 13 mm (0.51 inch)..

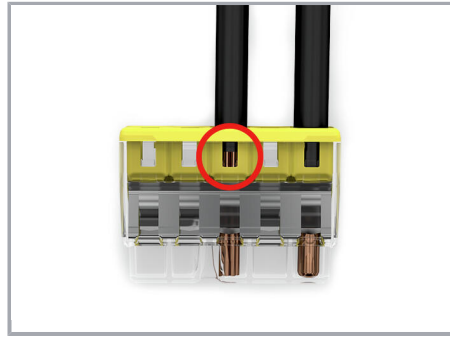

The transparent housing shows if conductors are fully inserted; within the colored base, a clear port shows if the conductor's strip length is correct. Conductors are correctly stripped if the clear port shows no bare conductor on the unprinted connector side. Picture shows center conductor with exceeded strip length.

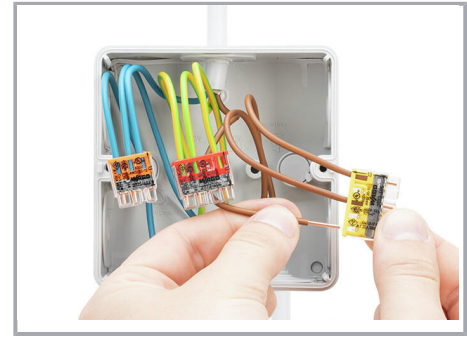

Termination: Insert the stripped conductor until it hits the backstop.

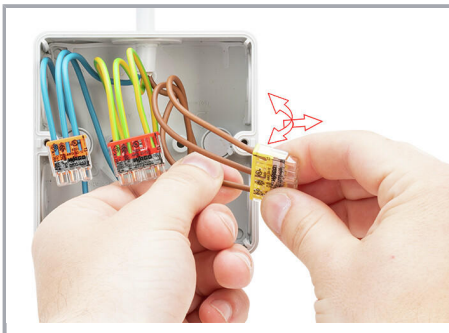

Removal: Hold solid conductor to be removed and twist alternately left and right while pulling the connector.

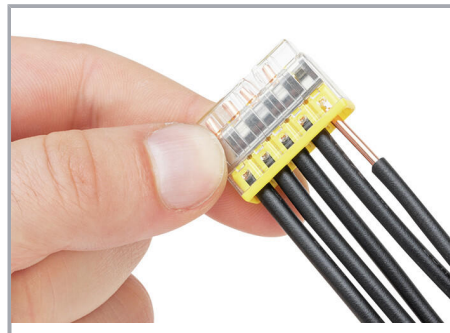

Solid conductors are inserted into the connector by simply pushing them in.

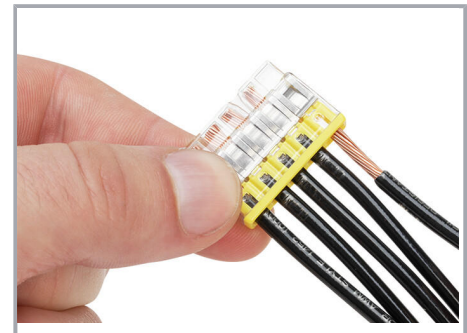

Stranded conductors are inserted into the connector by simply pushing them in.

Testing

Med forbehold om endringer. Vær også oppmerksom på ytterligere produktdokumentasjon!

WAGO Norge AS
Jerikoveien 20
1067 Oslo
Tel.: +47 22 30 94 60 | Fax: +47 22 30 94 51
Email: info.no@wago.com

Har du spørsmål om våre produkter?
Vi tar alltid gjerne imot di samtale på +49 (571) 887-44222.



Testing via test port opposite to conductor entry.

Application

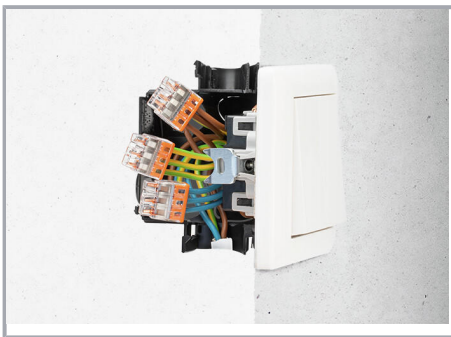

Thanks to their flat and compact design, these connectors are ideal for wiring in flush-mount switch boxes.

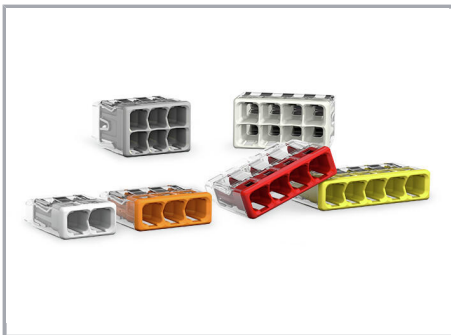

With six variants, always have the right connector.

Med forbehold om endringer. Vær også oppmerksom på ytterligere produktdokumentasjon!

WAGO Norge AS
Jerikoveien 20
1067 Oslo
Tel.: +47 22 30 94 60 | Fax: +47 22 30 94 51
Email: info.no@wago.com

Har du spørsmål om våre produkter?
Vi tar alltid gjerne imot di samtale på +49 (571) 887-44222.