

ACS-30-EU-VIA-DU-20-MOD

nVent

RAYCHEM

MULTI-APPLICATION HEAT TRACING CONTROL & MONITORING IN COMMERCIAL AND RESIDENTIAL BUILDINGS

SURFACE SNOW MELTING SENSOR MODULE

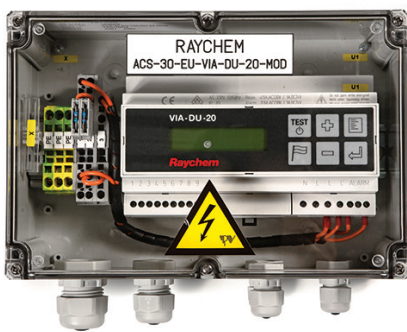

DESCRIPTION

The nVent RAYCHEM ACS-30-EU-VIA-DU-20-MOD Module for the ACS-30 system provides smart sensor input for surface snow melting and de-icing applications. The module provides ground temperature and moisture sensing for the ACS-30 control system. The module can be positioned near to the heated area and is connected to the PCM module via a 3-wire cable. The module is provided with a 15 m external ground temperature and moisture sensor to be positioned at the heated surface.

The output from the ACS-30-EU-VIA-DU-20-MOD module enables the switching of the heating circuits within the power & control module (PCM).

TECHNICAL INFORMATION

Approvals	CE marked Control Device VIA-DU-20 VDE approved.
Module IP rating	IP55 (enclosure with control device)
Ambient operating temperature range	0 to +35°C (enclosure with control device)
Mounting	Wall mounting

ENCLOSURE

Dimensions	332 mm x 262 mm x 132 mm
Enclosure type	Polystyrene box and polypropylene cover
Connections	5 Polyamide Cable Glands (IP68 rated) with stopping plugs

CONTROL DEVICE

Device	VIA-DU-20 controller
Display	Dot Matrix, 2x16 digits
Power consumption	14VA max.
Voltage	230Vac, +/-10%, 50/60Hz
Switching Accuracy	+/-1K.
Terminals	0.5 - 2.5mm ²
Terminals	2.5mm ² (stranded conductors), 4 mm ² (solid conductors)

GROUND MOISTURE AND TEMPERATURE SENSOR (VIA-DU-S20)

PTC Sensor (IP67). Supplied with 15m cold lead. Extendable to 50 m (5 x 1.5 mm ²).	
Diameter of cold lead	5 x 0.5 mm ² , d. 5.7 mm
Ambient operating temperature range	-30°C to +80°C
Supply voltage	8V DC (via control device)

AMBIENT SENSOR (OPTIONAL)

PTC Sensor (IP54). Cable not included. Max length 100 m (2 x 1.5 mm²).

Ambient operating temperature range -30°C to +80°C

Terminals 1.5 - 2.5 mm²

Mounting Wall mounting

A CONTROLLER

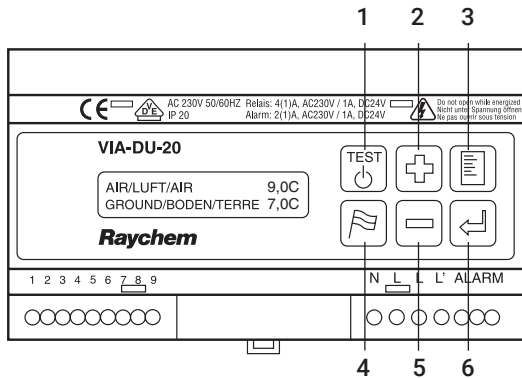

Detail of the display/buttons

1. Test button
2. Increasing the value selected, changing settings (forwards)
3. Menu button
4. Selecting a language (D, GB, F, I, FIN, PL, H)
5. Reducing the value selected, changing settings (backwards)
6. Confirm button

B VIA-DU-S20

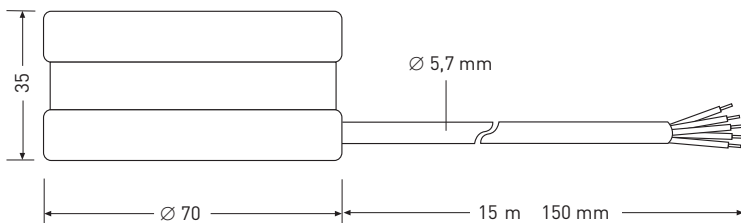

Dimensions in mm

C VIA-DU-A10

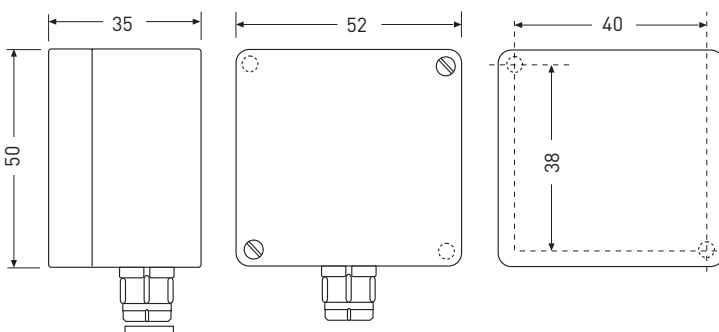

Dimensions in mm

1. FUNCTION

- The ground temperature and moisture are measured with the help of one sensor.
- The sensor is heated so that it can also measure dry snow.
- The control device evaluates the data from the sensor and provides the signal to the PCM to switch on the heater, if the ground temperature falls below a value set by menu and the ground moisture exceeds a value set by menu.
- In addition the device is capable of identifying a risk of freezing rain. This function serves to switch the heating on when freezing rain is predicted.
- The controller also has what is called an overruling entry. This can be configured using the menu and serves to prevent over-loading.

2. DISPLAY AND CONTROLS

The device has a display which is lit when the device is being operated (see A). Under normal operating conditions the device alternately shows the moisture, the ground and air temperature and the status of the heating output. Only the values, which are relevant for controlling, are shown. Air temperature e.g. is only shown, if "sleet precaution" is set to "local detection".



Testing the device / switch on the heating output



Selecting a language



Increasing the value selected, changing settings (forwards)



Reducing the value selected, changing settings (backwards)



Enter menu, exit menu



Confirm the value selected, select the next value and responding to fault messages.

3. OPERATION

3.1. Selecting a language

You can select a language by pressing the button  once or more. The languages available are German, English, French and Italian. The language can be changed regardless of the operating status.

After 2 seconds the device automatically returns to where it was when the language selection procedure was called up (Normal display, test or parameter menu).

Example of display when selecting a language:

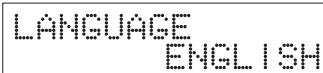

```
LANGUAGE
ENGLISH
```

3.2. Testing mode

Pressing the  once switches the heating timer on for 30 min. The display indicates the time remaining, the software version number and the status of the heating output. The test mode can be selected at any stage. It should however be remembered that any heating periods underway will be interrupted. So for example, selecting the test mode will interrupt the post-heating period.



The test finishes once the test time has elapsed, but can also be terminated by pressing the  button while the test is still underway. When the test mode has been terminated the device will return to the standard display.

Display in test mode (example):



```
TEST  V2.3  29:50  
HEATING  ON
```

3.3. Operation of the parameter menu

The parameter menu can be called up by pressing the  button. The parameter displayed may be modified using the  and  buttons.

If the buttons are pressed down for an extended period the value changes automatically (autorepeat function). Pressing  and  down at the same time will reset the parameter to the default setting.

Now you can switch to the next parameter with the button  or you can leave the parameter menu by pressing the  button.

If you have changed a parameter and want to switch to the next or leave the menu, there appears "SAVE CHANGES" in the display. You can select "YES" or "NO" using the  and  buttons. Having confirmed this with the  button, device switches to the next parameter or leaves the parameter menu with or without saving changes.

Confirming the final parameter, the device goes back to the standard display.

The following menu points can be set or called up:

```
TEMP. SET POINT  
3,0°C
```

Range of settings: +1.0 °C ... +6.0 °C
Interval: 1.0 K
Default setting: 3.0°C

The temperature threshold is used to set the value below which the ground temperature must fall for the heating to come on, providing there is sufficient moisture. The temperature threshold also is the set point for the sensor heating, i.e. there is the possibility to control the sensor heating by this value.

Attention: If the temperature threshold is set to 1.0°C or 2.0°C, the sensor may freeze in. In this case reliable detection of moisture can not be guaranteed.

The value of moisture is no longer indicated in the display.

```
MOISTURE SET PT.  
3
```

Settings: OFF, 1 ... 10
Interval: 1
Default setting: 3

The moisture threshold determines the level of moisture which must be exceeded for the heating to come on, providing the temperature is low enough. 1 is the most sensitive setting, i.e. very little moisture is enough to reach this value.

If the moisture threshold is set to 'OFF', the control device will always switch the heating on, as long as the temperature falls below the threshold value. No moisture is required. The value of moisture is no longer indicated in the display.

```
MIN. HEAT TIME  
30min
```

Range of settings: 30 ... 120 min.
Interval: 10 min.
Default setting: 0 min.

The post-heating period is the time for which the device continues to heat after the threshold conditions which set the heating on are no longer present.

```
LOW TEMP. LIMIT  
OFF
```

Range of settings: OFF, -15°C, ... -1.0°C
Interval: 1.0 K
Default setting: OFF

If the temperature in the ground falls below the base value, the control device will keep on heating (regardless of the moisture). This functions speeds up the time required to clear the surface from snow and ice. If the ground temperature rises above the base temperature again, the heating timer will remain switched on for the post-heating period.

SLEET PRECAUTION
LOCAL DETECTION

Range of settings: LOCAL DETECTION,
WEATHER FORECAST, OFF

Default setting: LOCAL DETECTION

This function addresses the issue of freezing rain, the purpose is to preheat the surface to prevent the associated problems.

* For the purpose of the use of VIA-DU-20 in the UK, 'sleet' is used to describe the condition and effect of freezing rain.

This can be done in two different ways:

1. Local detection freezing rain warning

If the device is set to LOCAL DETECTION, i.e. local detection of risk of freezing rain, the device will heat the surface as soon as it notices a sharp rise in temperature after a lengthy period of cold weather.

The rise in air temperature is performed by an air temperature sensor which is delivered together with the device.

The device can recognise a lengthy period of cold weather by means of a ground temperature sensor, if the ground temperature has been below a set value for 18 hours. See also the sections on the rise in temperature and the low ground temperature for an 18 hour period in the paragraphs relating to the following parameters.

2. Freezing rain warning via the weather service

With this function, the device waits for a logic signal sent from an additional device to the terminals of the air temperature sensor. The additional device, which is not part of the standard package, evaluates information from the weather service and converts these into the relevant logic status.

The control device expects the following logic status:

Logic status	Input in control device	Reaction of the control device
0	open	Heating OFF (no risk of freezing rain)
1	short circuit	Heating ON (risk of freezing rain)

Instructions for early recognition of freezing rain

- If it has recognised the possibility of a fall of freezing rain, the device switches on for 5 hours. If the warning has come via the weather service, the five-hour period begins from the moment the logic status signal changed from 0 to 1. The heating is switched off as soon as the ground temperature reaches the threshold value or the five hours have elapsed. If however, after five hours, the ground temperature and moist conditions are present for heating to continue, the heating is not turned off, i.e. following the five-hour period the device continues to operate under normal operating conditions.
- If the device is set for the local detection freezing rain warning, you should ensure that the base temperature is lower than the 18-hour ground temperature value, since otherwise the temperature will never fall below the 18-hour value and the freezing rain warning will not function.
- The reliability of the early recognition function heavily depends on the correct setting of the parameters. It is possible that ice may build up on the surface or the device may come on unnecessarily.

AIR TEMP. INCREASE
2,0K/h

Range of settings: 0.5K/h ... 4.0 K/h

Interval: 0.5 K/h

Default setting: 2.0 K/h

This parameter* is used for setting the minimum rise in the air temperature in order to recognise the potential risk of freezing rain after a lengthy period of cold weather.

18H-GROUND TEMP.
-1,0 C

Range of settings: -15°C ... -1.0°C
Interval: 1.0 K
Default setting: - 1.0°C

* This parameter temperature is indicated only when "local detection" is selected.

This parameter* is used to set the value below which the air temperature must fall for a period of at least 18 hours. If this condition is fulfilled and the temperature rises sharply, there is a risk of freezing rain. Make sure that the base temperature is set lower than the ground temperature value for the 18-hour period. Otherwise the temperature will never fall below the value for the 18-hour period and the freezing rain warning will not work.

OVERRULING
OFF

Range of settings: OFF, ON, BMS
Default setting: OFF

The OVERRULING parameter is used to configure the relevant logic input. If the parameter is set to 'OFF' the input is not evaluated by the control device. The control device is not affected.

In the 'ON' setting the control device cannot switch the heating on for 10 min. if the input is or was short-circuited. This prevents peakloads in buildings. If the input is still short-circuited or has short-circuited again after 10 minutes have elapsed, the device cannot turn on the heating for another 10 minutes.

If the device is set to 'BMS' the heating output is remote controlled. If the input is short-circuited, the control device switches the heating off. If the input is open, the device will switch on the heating in any event.

Note: nVent recommends not to use the BMS settings in the ACS-30-EU-VIA-DU-20-MOD.

The connection to a BMS system can be done via the ACS-30-EU-UIT2 using the Protonode gateway modules or configuring the application as External Device Control Mode (for more information refers to the manual of ACS-30-EU-UIT2 or contact your nVent representative).

The sensor values of the ice indicator are not displayed and not evaluated.

IN CASE OF ERROR
HEATING OFF

Range of settings: OFF, ON
Default setting: OFF

This parameter allows you to select what status the heating timer should assume in the event of a fault. The 'OFF' setting is recommended for all energy sensitive applications, whereas the 'ON' setting should be selected for safety applications.

This menu option indicates the heating time in hours (H) and minutes (M).

Using the  and  buttons the counter can be reset

4. ADVICE, FAULT MESSAGES AND SERVICING

4.1. What to do during set up

When the device is first put into operation it carries out an auto-test. During this test the display indicates, "POWER-UP TESTS". If the device finds a fault during this test, it displays a number on the second line of the display. Otherwise the device goes into the standard operating mode.

* This parameter is indicated only when "local detection" is selected.

If a fault is identified, you should carry out another test by switching the device off and on again. If the fault message is displayed again, the device is faulty and must be replaced.

If the fault message is displayed indicating the number '6', perhaps one of the buttons is stuck. In this case, the keyboard must be checked. Then switch the device off and on again for another test.

4.2. What to do in the event of a loss of power

If there is a loss of power, all parameters will remain saved in the memory. Both relays (heating and alarm) will stop working.

After the power failure, the device will continue to operate in its state when the power loss occurred. The timers will remain constant during power loss (no reserve power supply).

4.3. Sensor monitoring

The ground temperature and moisture sensor and the air temperature sensor are monitored for faults (breakage and short circuits) by the control device. If a fault occurs, the alarm relay switches and the display indicates, "SENSOR FAULT" and a corresponding fault message is emitted. The following fault messages are used:

Display	Type of fault
SHORT GROUND TMP	Ground sensor short circuit
OPEN GROUND TMP	Ground sensor interrupted
MOISTURE	General fault in the moisture measurement device. Possible faults: there are conductive objects touching one or both sensors or the control device input is faulty.
SHORT AIR TMP	Short circuit in the air temperature sensor*
OPEN AIR TMP	Interruption of air temperature sensor*
SHORT SENSHEATER	Short circuit in the sensor heating (is recognised if the temperature of the ground sensor remains below +2°C for longer than 2 hours)
OPEN SENSHEATER	Sensor heating interrupted

A failure will interrupt heating times, such as the post-heating period. The heating output will be turned on or off as set under the parameter "IN THE CASE OF FAILURE HEATING..."

* The monitoring of air temperature is only active when "local detection" is selected.

4.4. Trouble shooting

Symptoms	Probable	Correction
Status of the heater is ON, but there is no moisture	Setting overruling BY BMS is selected	If necessary change settings
	Setting moisture threshold OFF is selected	If necessary change settings
	The device has detected a temperature drop and heating is on for post heating period	This is normal operation
The device shows moisture 0, while sensor is moist	The sensors surface is soiled (oily)	Clean the surface of the ground sensor with a flannel and water. The surface of the sensor must not be scratched with sharp objects.
	The moisture on the sensor is frozen	Set the temperature threshold to a higher value. This gives a higher set point for sensor heating, too.
Heating is OFF although there is moisture on sensor	Moisture threshold too high	Set the moisture threshold to a lower value
	Temperature threshold too low	Set the temperature threshold to a higher value
	The device is set in over- ruling ON and the logic input is short-circuited	If necessary change settings
Heating is regularly OFF, but area is not yet free of ice and snow	The post-heating period is too short	Set a longer post heating period
	The sensor is dry, but there is ice and snow on the heated area	Set the temperature threshold to a lower value. This gives a lower set point for sensor heating, too.

Attention: Please change settings step by step to ensure reliable function. Also with careful settings it can't be guaranteed, that the heated area is always free of snow and ice.

4.5. Servicing

Neither control device nor any of the sensors require any servicing.

The surface of the ground sensor needs to be cleaned regularly, to ensure that it gives correct moisture measurements. A flannel and tap water may be used. The surface of the sensor must not be scratched with sharp objects. It is recommended that you check that the device is working before the onset of winter.

5. INSTALLATION INSTRUCTIONS

Only for electricians!

Attention: mistakes during connecting up the device can cause damage to the control unit. nVent is not liable for any damage caused by faulty connections and/or incorrect handling.

- Before working on the device, switch off the power supply!
- The device may only be connected and serviced by authorised, trained electrician.
- Electrical connection must be carried out according to the enclosed connection diagram.
- Do not lay low voltage cables sensor cables together with other live high voltage cables in order to avoid electromagnetic interference.
- Local standards for electrical connection must be observed.
- If the device does not work please first check all connections and the mains power supply.

6. ASSEMBLY

6.1. Assembly of the control device

Select a suitable location for the enclosure and mount it on a wall using suitable screws.

Install power cable, moisture and ambient sensor cables, RTD cables (which has to be connected in the ACS-30-EU-PCM2 module) into the enclosure using the glands supplied.

Keep stopping plugs in unused entries.

6.2. Assembly of the ground temperature and moisture sensor VIA-DU-S20

The sensor is yellow and can be recognised by its 5-core connection lead.

It has the following dimensions: see **B**

The ground temperature and moisture sensor is to be installed within the heated area at least 2.5 cm and maximum 15 cm away from the heating cables (see diagram). The sensor must be able to directly detect weather conditions (rain, snow, melted snow and ice). The sensor may not be covered up (e.g. when clearing the snow). Take care that VIA-DU-S20 is not installed in an area which is continuously flooded with water (e.g. drain line), neither in an area which is continuously under ice due to external parameters (e.g. freezing of condensation water in cooling rooms).

The piece of wood is placed into the ground surface as a dummy for the sensor.

A metal protective pipe is to be installed up to the wooden piece. The pipe is to be secured on the wooden piece to prevent concrete, asphalt, etc. from getting in. Once the material has been put on and if necessary cooled, the piece of wood is removed and the sensor fitted into the hole. The sensor must be mounted absolutely horizontal. The remaining space around the sensor is to be filled with, for example, silicon, mortar or asphalt. The temperature of the filling material must not exceed 80°C. Furthermore, it has to be ensured that there is a good connection without hollow space between the sensor and the filling material. The sensor connection lead may be extended from 15 m (standard length) to a maximum of 50 m with a diameter of 1.5 mm².

Picture 1

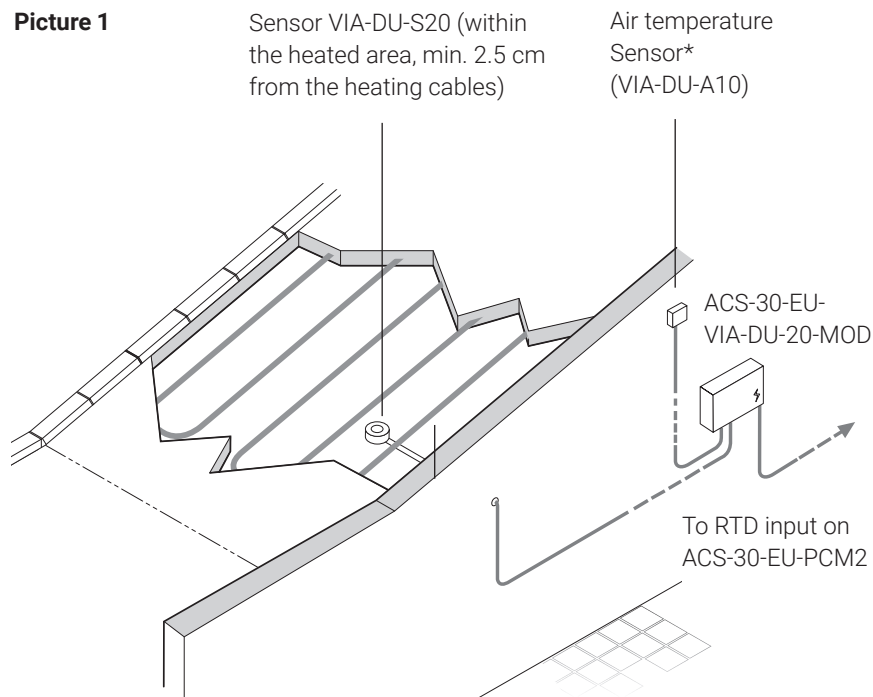

* Optional, only needed when "local detection" is selected.

Picture 2

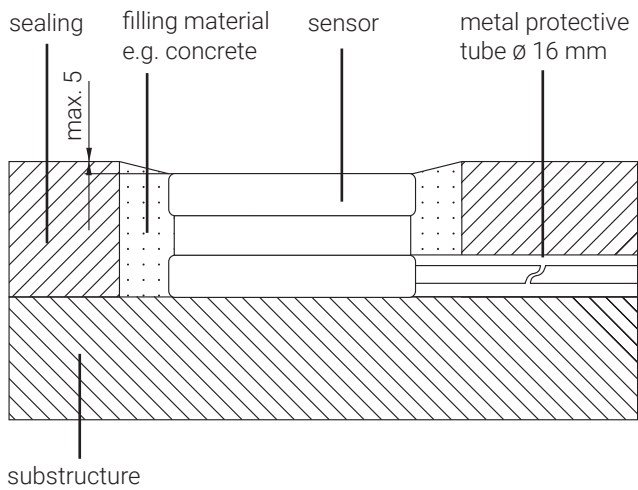

Picture 3

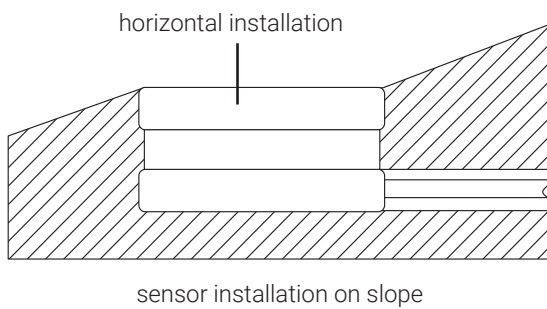

6.3. Assembly of air temperature sensor VIA-DU-A10

The sensor has the following dimensions: see **C**

The air temperature sensor should be installed approx. 2-3 m above the ground in a protected place (with a shelter). It must not be exposed to direct sunlight. It must also be protected from external influences, i.e. it must not be installed above doors or windows or near lamps or headlights.

The sensor connection lead may be up to 100 m long, given a diameter of 1.5 mm².

7. WIRING DIAGRAM

7.1. VIA-DU-20 with contactor

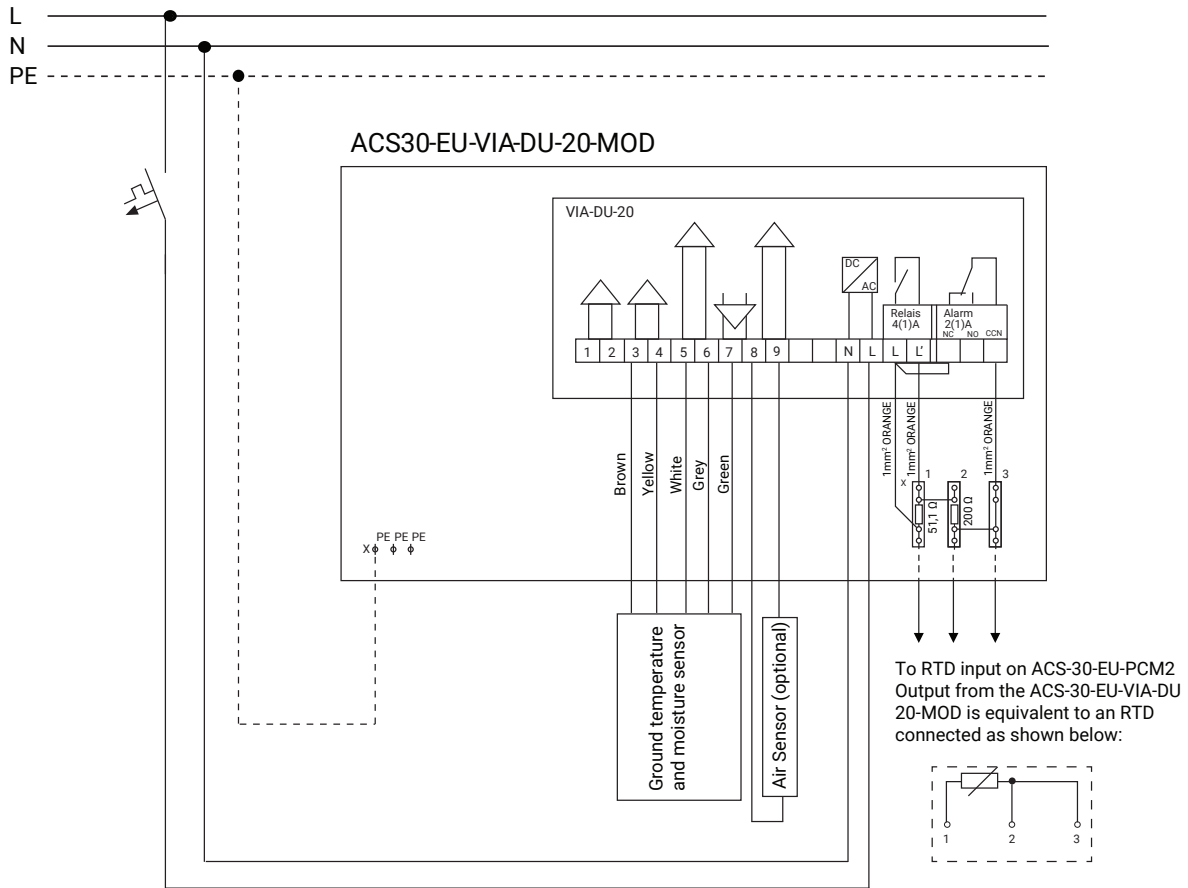

PART NUMBERING AND ORDERING DESCRIPTION

PCN	Product Name	Description	EAN Code
1244-012866	ACS-30-EU-VIA-DU-20-MOD	Surface snow melting & de-icing sensor for ACS-30.	5414506014327

RELATED PRODUCTS

PCN	Product Name	Description	EAN Code
1244-012864	ACS-30-EU-UIT2	User Interface module for the ACS-30 Control and Monitoring System	5414506014303
1244-012865	ACS-30-EU-EMDR-10-MOD	Gutter & Roof snow melting sensor module for the ACWS-30 Control and Monitoring System	5414506014310
1244-012866	ACS-30-EU-VIA-DU-20-MOD	Snow melting and surface de-icing sensor module for the ACS-30 Control and Monitoring System	5414506014327
1244-012867	ACS-30-EU-Moni-RMM2-E	Remote monitoring module for the ACS-30 Control and Monitoring System	5414506014334
1244-012871	ACS-30-EU-PCM2-5-32A	Power Control Module for ACS-30 (5 circuit module with 32 Amp electrical protection per circuit)	5414506014372
1244-012872	ACS-30-EU-PCM2-10-32A	Power Control Module for ACS-30 (10 circuit module with 32 Amp electrical protection per circuit)	5414506014389
1244-012873	ACS-30-EU-PCM2-15-32A	Power Control Module for ACS-30 (15 circuit module with 32 Amp electrical protection per circuit)	5414506014396

United Kingdom

Tel +0 800 969 013
Fax +0 800 968 624
salesthermalUK@nvent.com

Ireland

Tel +1800 654 241
Fax +1800 654 240
salesIE@nvent.com



nVent.com

Our powerful portfolio of brands:

CADDY ERICO HOFFMAN RAYCHEM SCHROFF TRACER